



Katalog 2012



Felo Werkzeugfabrik
Holland-Letz GmbH
Emil-Rössler-Straße 59
D - 35279 Neustadt (Hessen)

Tel.: ++49 (0) 66 92 - 88 0
Fax: ++49 (0) 66 92 - 88 99
Email: info@felo.com
www.felo.com



62

years of Felo! Our customers and employees are proud of this anniversary. In 1950 Felo Werkzeugfabrik was founded in Neustadt (Hessen). Driven by innovative power, quality consciousness and enthusiasm the company grew from humble beginnings with 2 employees into one of the leading manufacturers of screwdrivers and bits. Today 200 people work for Felo.

62 Jahre Felo! Ein Jubiläum auf das unsere Mitarbeiter und Kunden stolz sind! Die Felo-Werkzeugfabrik wurde 1950 in Neustadt (Hessen) gegründet. Aus bescheidenen Anfängen mit 2 Angestellten entstand durch Innovationskraft, Qualitätsbewusstsein und Begeisterung einer der weltweit führenden Hersteller von Schraubendrehern und Bits. Heute arbeiten 200 Mitarbeiter für Felo.



2000

stocked items are at the daily disposal of our customers. On top of this we manufacture the same number of products in customized versions, as special tools and under private brand.

2000 Artikel stehen unseren Kunden täglich ab Lager zur Verfügung. Zusätzlich fertigen wir etwa die gleiche Anzahl von Produkten in Sonderausführungen, als speziell entwickelte Problemlösungen oder unter Kunden-Marken.

134

years of experience in the development, production and marketing of screwdrivers.

In 1878 the »Hammermühle« factory for tools was founded. The product range included forged screwdrivers as well as chisels, hammers and pliers. The foundation of Felo in 1950 was based on this company.

134 Jahre Erfahrung in der Entwicklung und Herstellung von Schraubwerkzeugen. 1878 wurde in Thüringen die Werkzeugfabrik »Hammermühle« gegründet. Das Sortiment umfasste geschmiedete Schraubendreher, sowie Meißel, Hämmer und Zangen. Aus diesem Unternehmen ging 1950 Felo-Werkzeugfabrik hervor.



40

Felo tools are exported to 40 countries: we are a global player and specialist, offering a wide variety of products for the most different markets and requirements. Felo is traditionally strong in exports: almost 100 years ago we began using catalogues in 4 languages. Since then Felo has become a byword for quality.

40 Länder in die Felo Werkzeuge exportiert werden: wir sind ein weltweit tätiges Unternehmen, das als Spezialist eine große Programmtiefe anbietet und sich damit auf unterschiedlichste Märkte und Bedürfnisse einstellen kann.

Traditionell exportstark: bereits vor fast 100 Jahren verwendeten wir die ersten viersprachigen Kataloge. Seitdem wird Felo Werkzeug in vielen Teilen der Welt als Inbegriff von Qualität geschätzt.



260

applications for industrial property rights document our innovative power!

Progressive ideas like 2-component handles, Titanium-coated bits and screwdrivers with exchangeable blades for electricians originated from Felo developments. Our curiosity and creativity have made us a leader in product and production.



























260 Schutzrechtsanmeldungen dokumentieren unsere Innovationskraft! Wichtige Fortschritte, wie der 2-Komponentengriff, TiN Bits oder Wechselslingen-Systeme für Elektriker gehen auf Entwicklungen von Felo zurück. Unsere Neugier und Kreativität haben uns in den Bereichen Produkt und Produktion zu einem der weltweit führenden Hersteller werden lassen.

1

mission: We want to inspire our customers!
This doesn't just show in our products but also in our flexibility, customer service, reliability and cost-efficiency.
Test for yourself our strengths!

*1 Ziel: Wir wollen unsere Kunden begeistern!
 Dies spiegelt sich nicht nur in den Felo Produkten wider, es zeigt sich auch bei Flexibilität, Service, Zuverlässigkeit und Kosteneffizienz.
 Überzeugen auch Sie sich von unseren Stärken!*



										
	Rgonic®	frico	frico	PP	PP	Wood	VDE	Nm	Series 240/ 250 ESD & 280	
	Series 400	Series 550	Series 500	Series 206	Series 200 290 ESD	Series 330/ Series 490	VDE/ Insulated	Series Nm	Series 240/ 250 ESD & 280	
	Pg/S.	Pg/S.	Pg/S.	Pg/S.	Pg/S.	Pg/S.	Pg/S.	Pg/S.	Pg/S.	
	6 - 15	16 - 19	20 - 31	32 - 33	42 - 45	42 - 45	46 - 61	62 - 65	66 - 71	
for slotted screws <i>Schlitzschrauben</i>		8-10, 12-14	17-19	21-22, 24-25, 27-31	33	35-41	43-44	47-49, 51, 53-61	63-65	37, 67, 69-71
PH Phillips		8-10, 12-14	17-19	21-22, 24-25, 27-31	33	35-41	43-44	47-49, 51, 53-60	63-65	37, 67, 69-71
PZ Pozidriv-Superdriv		8-10, 13-14	17	21-22, 24, 27, 29-31	33	35-36, 38, 40-41	43-44	47-49, 51, 55-59	63-65	67, 69-71
+ / - Plus - Minus								48-49, 52	65	
Torx® Torx		11, 13, 15		23-24, 27-29		36, 39		47, 49, 52, 56	63-65	68-71
Torx TR Torx® Tamper Resistant				22, 30						
Torx Plus® IP				23					63-65	
Inner Hexagon Innensechskant				26					65	68-71
Nut Drivers Steckschlüssel		11-12, 15		26				52, 54		68-69
SQ Square for Robertson® screws		10, 14								
XZN XZN										
Clutch										
Spanner								48		
TS for TorqSet® screws										
Tri-Wing®										
LocTec®										
Bitholder/Bithalter		12, 152		25-26				56, 152	63-65	71



Series 370 Pg/S. 72 - 73	T-Handles/ Series 340 Pg/S. 74 - 77	Hexagon Key Products Pg/S. 78 - 85	R-GO XS Pg/S. 86 - 93	smart Esmart Pg/S. 94 - 103	Challenger / TiN / 020 - 030 Pg/S. 104 - 123	Bit-Sets Pg/S. 124 - 143	Special-Bits Adapters Bitholders Pg/S. 144 - 155	Pliers Pg/S. 156 - 159	Displays Pg/S. 160 - 179
73	77		87, 89, 91-92	95-99, 101-103	104, 106, 108-110, 115, 117, 119, 120-123	125-126, 129, 131-134, 136-140, 143	146-149		160-175
73	77		87, 89, 91-92	95-99, 101-103	104-109, 111, 115, 117, 119-123	125-126, 128-140, 142-143	146-148, 150-151		160-175
73	77		87, 89, 91-92	95-99, 101-103	104-109, 111, 115, 117, 119-123	125-143	146, 148-149		160-175
				101-103	118				
73	76	79-81	87, 89, 92	95-99, 101-103	105, 107-108, 112, 116, 118, 120-121, 123	125-128, 130-133, 135-141, 143	148, 150-151		165-166, 168-175
			92	99	113, 123	131, 142-143			
		79-81			113, 115				
	75-77	82-85	87, 89, 92	95-96, 98-99	112, 116, 122	132-133, 140-141	146, 148, 150		169, 174
	75		87-89, 91, 93	95-99		140	145		169, 175
			89	99, 103	112, 118	132			
				99	114	142	151		
					113	142			
			89	101	114	132, 142			
					114	142			
					114	142			
							144		
73	76		87-89	95-97, 99		125-134, 136, 139-143	152-154		165, 173-176



Ergonic, the first handle that adapts to the users hand!

Ergonic, der erste Griff, der sich der Hand anpasst!



smooth, seamless handle for maximum comfort

nahtfrei glatte Kappe für minimale Reibung

hand and handle interlock, causing less strain

Hand und Griff verzahnen sich – der Kraftaufwand sinkt

Serie 400 *ERGONIC*® (pat.)

EP 1963072

stronger / stärker
adaptable / anpassungsfähig
truly ergonomic / wirklich ergonomisch

hexagon bolsters available on series 410

Sechskant-Schlüsselhilfe bei Serie 410

blades manufactured from chrome-molybdenum-vanadium steel

Klingen aus spezieller Chrom-Molybdän-Vanadium-Legierung

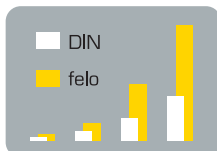

superior torque which exceeds DIN and ISO requirements by up to 100%

Beste Leistungsdaten, bis zu 100% über DIN-Werten



GS tested for safety

GS – geprüfte Sicherheit



EAN code on every product

EAN-Code auf jedem Werkzeug



black tip for precision fit

Black-Tip zur Erhaltung der Präzision und Passgenauigkeit

anti-roll handle design

Griffkopf mit Abrollschutz

hanging hole for easy storage or inserting lever

Querloch: Zum Aufhängen der Werkzeuge oder zum Einstecken eines Hebels

screw symbols on handle cap

Schraubensymbole auf Griffkappe



full length, impact proof handle core

durchgehender, schlagfester Hartkern

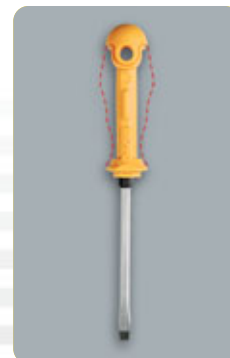



There are numerous ergonomic handle designs: It is always the user's hand that has to adjust to the handle. ERGONIC is the only handle adjusting to the individual hand!

Es gibt viele ergonomische Griffe: Immer ist es die Hand, die sich an den Griff anpassen muss. ERGONIC ist der einzige Griff, der sich jeder Anwenderhand anpasst!

The new standard in ergonomics, torque transmission and responsiveness!

Der neue Maßstab für Ergonomie, Kraftübertragung und Feinfühligkeit!

ERGONIC®

The impact proof handle core is coated with elastic, scratch resistant elastomer containing cells of highly flexible plastics.

Der Griffkern aus schlagfestem Hartkunststoff ist mit einem widerstandsfähigen elastischen Griffkörper ummantelt, in den Polster aus hochflexiblem Kunststoff eingelassen sind.



The handle fits perfectly into the hand at all times. Hand and handle interlock, causing less strain and work fatigue, allowing higher maximum torque! Responsiveness of material results in enhanced sensitivity and perfect control of torque.

Der Griff füllt die Hand immer optimal aus: Hand und Griff verzahnen sich – der Kraftaufwand sinkt! Dadurch werden höhere Drehmomente und längeres ermüdungsfreies Arbeiten möglich. Die Flexibilität des Materials erhöht zusätzlich die Feinfühligkeit und ermöglicht den präzisen Krafteinsatz.



felo INNOVATIONEN

410



							Item No		EAN-Code
4,0 x 0,8	75	94	30	4,0	12		410 042 40	47	40 07157 53121 6
5,5 x 1,0	100	101	33	5,0	12		410 553 40	88	40 07157 52785 1
6,5 x 1,2	125	106	36	6,35	12		410 654 40	113	40 07157 52787 5
8,0 x 1,2	150	112	39	8,0	12		410 085 40	167	40 07157 52789 9
10,0 x 1,6	175	112	39	8,0	6		410 105 40	177	40 07157 53125 4
12,0 x 2,0	200	112	39	10,0	6		410 127 40	253	40 07157 53127 8

411



PZ							Item No		EAN-Code
1	80	94	30	5,0	12		411 102 40	60	40 07157 52791 2
2	100	106	36	6,35	12		411 203 40	106	40 07157 52793 6
3	150	112	39	8,0	6		411 305 40	172	40 07157 53129 2

412



PH							Item No		EAN-Code
1	80	94	30	5,0	12		412 102 40	60	40 07157 52795 0
2	100	106	36	6,35	12		412 203 40	105	40 07157 52797 4
3	150	112	39	8,0	6		412 305 40	169	40 07157 53131 5

410



	Item No		EAN-Code
Set 6-pcs / Satz 6-tlg.	410 961 48	538	40 07157 53167 4
(4 x) 400 - 410: 3,0 x 80 / 4,0 x 75 / 5,5 x 100 / 6,5 x 125			
(2 x) 412: PH 1 x 80 / PH 2 x 100			

410



Item No

410 962 48



542



EAN-Code

40 07157 53513 9

Set 6-pcs / Satz 6-tlg.

(1 x) 400: 3,0 x 80

(3 x) 410: 4,0 x 75 / 5,5 x 100 / 6,5 x 125

(2 x) 411: PZ 1 x 80 / PZ 2 x 100

410



Item No

410 963 48



630



EAN-Code

40 07157 53673 0

Set 6-pcs / Satz 6-tlg.

(2 x) 410: 5,5 x 100 / 6,5 x 125

(2 x) 411: PZ 1 x 80 / PZ 2 x 100

(2 x) 412: PH 1 x 80 / PH 2 x 100

410



Item No

410 931 48



336



EAN-Code

40 07157 53173 5

Set 3-pcs / Satz 3-tlg.

(2 x) 410: 5,5 x 100 / 6,5 x 125

(1 x) 412: PH 2 x 100

400

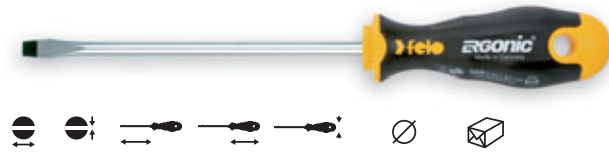

								Item No		EAN-Code
2,5 x 0,4	75	86	25	2,5	12			400 022 10	27	40 07157 53679 2
3,0 x 0,5	80	86	25	3,0	12			400 032 10	30	40 07157 53117 9
3,5 x 0,6	100	86	25	3,5	12			400 353 10	33	40 07157 53119 3
4,0 x 0,8	100	94	30	4,0	12			400 043 10	49	40 07157 53611 2
5,0 x 0,8	150	101	33	5,0	12			400 055 10	75	40 07157 53619 8
5,5 x 1,0	125	101	33	5,0	12			400 554 10	72	40 07157 53621 1
5,5 x 1,0	150	101	33	5,0	12			400 555 10	82	40 07157 53623 5
6,0 x 1,2	150	106	36	6,0	12			400 065 10	102	40 07157 57591 3
6,0 x 1,2	200	106	36	6,0	12			400 067 10	112	40 07157 57593 7
6,5 x 1,2	100	106	36	6,0	12			400 653 10	79	40 07157 53627 3
6,5 x 1,2	150	106	36	6,0	12			400 655 10	102	40 07157 52799 8
6,5 x 1,2	200	106	36	6,0	12			400 657 10	112	40 07157 53629 7
8,0 x 1,2	175	112	39	7,0	12			400 086 10	135	40 07157 52801 8
10,0 x 1,6	200	112	39	8,0	6			400 107 10	162	40 07157 53681 5

401

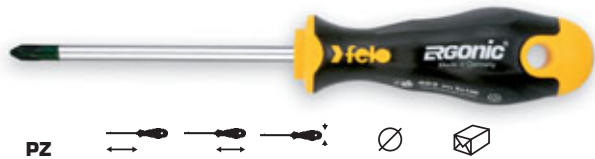

PZ								Item No		EAN-Code
1	80	94	30	4,5	12			401 102 10	50	40 07157 53683 9
2	100	106	36	6,0	12			401 203 10	92	40 07157 53685 3
3	150	112	39	8,0	6			401 305 10	148	40 07157 53687 7

402

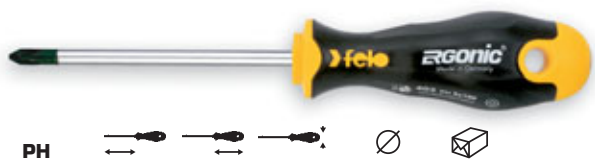

PH								Item No		EAN-Code
1	80	94	30	4,5	12			402 102 10	50	40 07157 52803 2
2	100	106	36	6,0	12			402 203 10	92	40 07157 52805 6
2	150	106	36	6,0	12			402 205 10	103	40 07157 53637 2
2	200	106	36	6,0	6			402 207 10	114	40 07157 53639 6
3	150	112	39	8,0	6			402 305 10	146	40 07157 53689 1

404

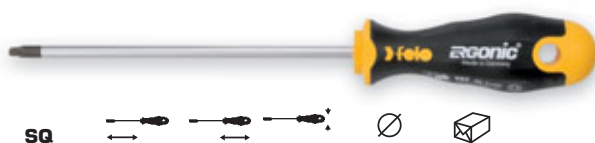

SQ								Item No		EAN-Code
0	100	94	30	3,0	12			404 000 40	44	40 07157 60309 8
1	120	94	30	4,5	12			404 100 40	56	40 07157 53507 8
2	160	106	36	5,0	12			404 200 40	91	40 07157 53509 2
3	160	106	36	6,0	12			404 300 40	105	40 07157 53511 5

408



Torx	Diagram			Ø	Box	Item No	Unit	EAN-Code
7	60	86	25	3,0	12	408 071 40	28	40 07157 52807 0
8	60	86	25	3,0	12	408 083 40	28	40 07157 52809 4
9	60	86	25	3,5	12	408 093 40	28	40 07157 52811 7
10	100	86	25	3,5	12	408 103 40	33	40 07157 52813 1
15	100	94	30	4,0	12	408 153 40	50	40 07157 52815 5
20	100	101	33	5,0	12	408 203 40	68	40 07157 52817 9
25	100	106	36	5,0	12	408 253 40	82	40 07157 52819 3
27	100	106	36	5,0	12	408 273 40	82	40 07157 52821 6
30	115	112	39	6,0	6	408 303 40	103	40 07157 52823 0
40	125	112	39	8,0	6	408 404 40	136	40 07157 52825 4

407



TorxTR	Diagram			Ø	Box	Item No	Unit	EAN-Code
10	100	86	25	3,5	12	407 103 40	33	40 07157 60903 8
15	100	94	30	4,0	12	407 153 40	50	40 07157 60905 2
20	100	101	33	5,0	12	407 203 40	68	40 07157 60907 6
25	100	106	36	5,0	12	407 253 40	82	40 07157 60909 0

428



M-TEC

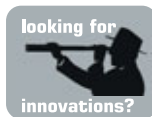

mm	Diagram			Ø	Box	Item No	Unit	EAN-Code
5,5	110	94	30		12	428 055 30	84	40 07157 60285 5
6	110	94	30		12	428 060 30	87	40 07157 60349 4
7	110	94	30		12	428 070 30	97	40 07157 60287 9
8	110	101	33		12	428 080 30	110	40 07157 60289 3
10	125	101	33		12	428 100 30	126	40 07157 60291 6
13	125	106	36		12	428 130 30	187	40 07157 60293 0

438

1/4"



Adapter for sockets 1/4" / Adapter für Steckschlüsseinsätze 1/4"						Item No	Unit	EAN-Code
100	101	33			6	497 110 40	107	40 07157 61479 7

429



mm						Item No		EAN-Code
5	170	106	36	6	6	429 050 40	148	40 07157 60355 5
6	170	106	36	6	6	429 060 40	148	40 07157 60357 9
7	170	106	36	6	6	429 070 40	148	40 07157 60359 3
8	170	106	36	6	6	429 080 40	151	40 07157 60361 6
10	170	106	36	6	6	429 100 40	151	40 07157 60363 0
1/4"	170	106	36	6	6	429 635 40	146	40 07157 60365 4

438

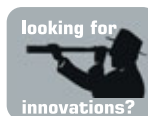

1/4"						Item No		EAN-Code
1/4"	100	101	33	6	6	438 125 40	102	40 07157 53711 9

Stubby



Stubby						Item No		EAN-Code
5,5 x 25	25	60	21	12	12	400 550 10	36	40 07157 61509 1
PH 2	25	60	21	12	12	402 020 10	38	40 07157 61511 4

Stubby



Stubby Bitholder 1/4" / Stubby Bithalter						Item No		EAN-Code
1/4"	18	62	25	12	12	438 026 40	48	40 07157 61727 9

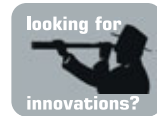

400



Item No



EAN-Code

Ergonic XXL-Rack 17-pcs / Rack 17 tlg.

400 917 43



2332



40 07157 60391 3

(5 x) 400: 3,0 x 80 / 4,0 x 100 / 5,5 x 125 / 6,5 x 150 / 8,0 x 175

(2 x) 401: PZ 1 x 80 / PZ 2 x 100

(2 x) 402: PH 1 x 80 / PH 2 x 100

(2 x) 413: 3,5 x 100 / 4,0 x 100    AC 1000V
IEC 60900 : 2004

(2 x) 414: PH 1 x 80 / PH 2 x 100    AC 1000V
IEC 60900 : 2004

(4 x) 408: Torx 10 x 100 / Torx 15 x 100 / Torx 20 x 100 / Torx 25 x 100

(1 x) **Steel Rack / Werkzeuhalter (Stahl)**



400



Item No



EAN-Code

Set 7-pcs / Satz 7-tlg.

400 971 18

602

40 07157 53695 2

(4 x) 400: 3,5 x 100 / 4,0 x 100 / 5,5 x 125 / 6,5 x 150

(1 x) 401: PZ 2 x 100

(2 x) 402: PH 1 x 80 / PH 2 x 100

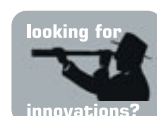

400



Item No



EAN-Code

Set 6-pcs / Satz 6-tlg.

400 961 18

548

40 07157 53691 4

(2 x) 400: 4,0 x 100 / 6,5 x 150

(2 x) 401: PZ 1 x 80 / PZ 2 x 100

(2 x) 402: PH 1 x 80 / PH 2 x 100

400



	Item No		EAN-Code
Set 5-pcs / Satz 5-tlg.	400 953 18	492	40 07157 57539 5
(3 x) 400:	4,0 x 100 / 5,5 x 125 / 6,5 x 150		
(2 x) 401:	PZ 1 x 80 / PZ 2 x 100		

400

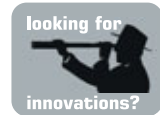

	Item No		EAN-Code
Set 5-pcs / Satz 5-tlg.	400 951 18	492	40 07157 53693 8
(3 x) 400:	4,0 x 100 / 5,5 x 125 / 6,5 x 150		
(2 x) 402:	PH 1 x 80 / PH 2 x 100		

400

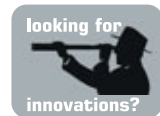

	Item No		EAN-Code
Set 3-pcs / Satz 3-tlg.	400 931 18	312	40 07157 53701 0
(2 x) 400:	5,5 x 125 / 6,5 x 150		
(1 x) 402:	PH 2 x 100		

404

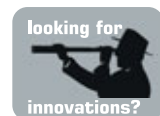

	Item No		EAN-Code
Set 3-pcs / Satz 3-tlg.	404 931 48	269	40 07157 53517 7
(3 x) 404:	SQ 1 / SQ 2 / SQ 3		

408



Set 6-pcs Torx / Satz 6-tlg.

Item No



EAN-Code

408 961 48

400

40 07157 53165 0

[6 x] 408: Torx 8 / Torx 9 / Torx 10 / Torx 15
Torx 20 / Torx 25

408



Set 3-pcs Torx / Satz 3-tlg.

Item No



EAN-Code

408 931 48

186

40 07157 53171 1

[3 x] 408: Torx 10 / Torx 15 / Torx 20

M-Tec
428



M-TEC



toolcase 6-pcs / Koffer 6-tlg.

Item No



EAN-Code

428 106 36

952

40 07157 61373 8

[6 x] 428: 5,5 x 110 / 6 x 110 / 7,0 x 110 / 8,0 x 110
10,0 x 125 / 13,0 x 125

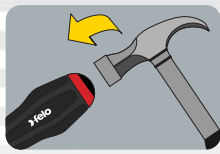

steelcap
Stahl-Schlagkappe



pleasant soft grip material for highest torque
angenehm griffiger Weichmantel für höchste Drehmomente



GS tested for safety
GS - geprüfte Sicherheit

The strongest of series 500 Die Stärksten aus der Serie 500 Serie 550

steelcap / Stahl-Schlagkappe
full length blade / Durchgehende Klinge
hexagon bolster / Schlüsselhilfe
hexagon blade / Sechskantklinge



hexagon bolster
Schlüsselhilfe

anti-roll handle design
Griffkopf mit Abrollschutz

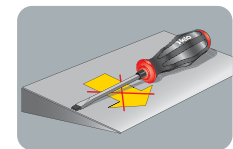

hexagon blades manufactured from chrome-molybdenum-vanadium steel
Sechskantklingen aus spezieller Chrom-Molybdän-Vanadium-Legierung

full length blade
Durchgehende Klinge

superior torque which exceeds DIN and ISO requirements by up to 100%

Beste Leistungsdaten, bis zu 100% über DIN-Werten

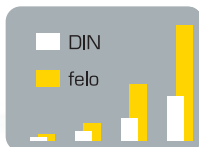

EAN code on every product

EAN-Code auf jedem Werkzeug

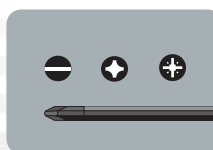

black tip for precision fit

Black-Tip für präzise Passung

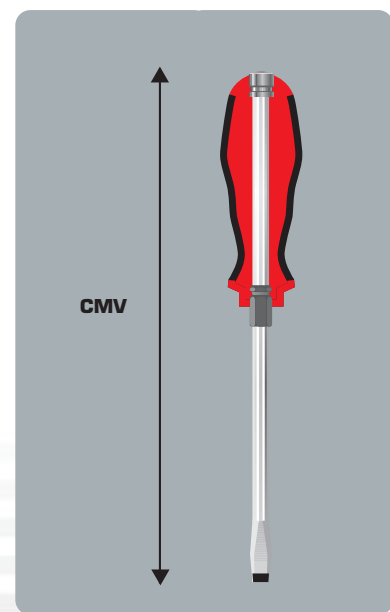

550



								Item No		EAN-Code
4,5 x 0,8	100	90	29	5,0	12		550 045 40	84	40 07157 50699 3	
5,5 x 1,0	100	99	34	5,0	12		550 055 40	101	40 07157 32354 5	
6,5 x 1,2	125	99	34	6,35	12		550 065 40	128	40 07157 32356 9	
8,0 x 1,2	155	105	38	8,0	6		550 080 40	202	40 07157 32358 3	
9,0 x 1,6	165	105	38	8,0	6		550 090 40	204	40 07157 50701 3	
10,0 x 1,6	175	105	38	8,0	6		550 100 40	211	40 07157 32360 6	
12,0 x 2,0	200	105	38	10,0	6		550 120 40	291	40 07157 32362 0	

551



							Item No		EAN-Code
PZ 1	90	90	29	5,0	12		551 102 40	82	40 07157 51701 2
2	100	99	34	6,35	12		551 203 40	122	40 07157 32364 4
3	155	105	38	8,0	6		551 305 40	202	40 07157 32366 8

552



							Item No		EAN-Code
PH 1	90	90	29	5,0	12		552 102 40	82	40 07157 50703 7
2	100	99	34	6,35	12		552 203 40	122	40 07157 32368 2
3	155	105	38	8,0	6		552 305 40	201	40 07157 32370 5

550

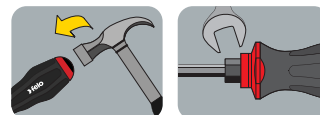

Item No

Set 6-pce / Satz 6-tlg

550 961 47



EAN-Code

1145

40 07157 53709 6

(3 x) 550: 6,5 x 1,2 x 125 / 8,0 x 1,2 x 155 / 10,0 x 1,6 x 175

(3 x) 552: PH 1 x 90 / PH 2 x 100 / PH 3 x 155

550

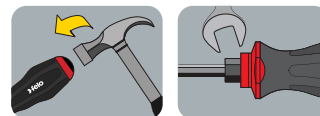

Item No

Set 5-pce / Satz 5-tlg

550 952 48



EAN-Code

633

40 07157 50707 5

(3 x) 550: 4,5 x 100 / 5,5 x 100 / 6,5 x 125

(2 x) 552: PH 1 x 90 / PH 2 x 100

550

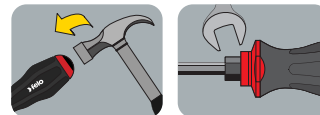

Item No

Set 5-pce / Satz 5-tlg

550 951 48



EAN-Code

870

40 07157 32386 6

(3 x) 550: 5,5 x 100 / 6,5 x 125 / 8,0 x 155

(2 x) 552: PH 2 x 100 / PH 3 x 155

550

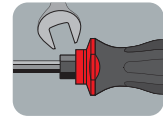

Item No



EAN-Code

Set 3-pce / Satz 3-tlg

550 932 44

481

40 07157 53669 3

(3 x) 550 5,5 x 100 / 6,5 x 125 / 8 x 155

550

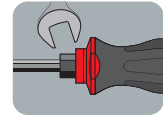
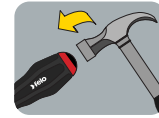

Item No



EAN-Code

Set 3-pce / Satz 3-tlg

550 931 44

382

40 07157 53667 9

(1 x) 550 6,5 x 125

(2 x) 552 PH 1 x 90 / PH 2 x 100



Professional users in particular appreciate the refined details of our tools.

Besonders professionelle Anwender schätzen die gut durchdachten Details unserer Werkzeuge.

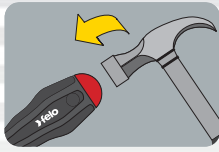

full length, impact proof handle core
durchgehender, schlagfester Hartkern

smooth, seamless handle for maximum comfort

nahtfrei glatte Kappe für minimale Reibung

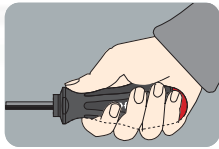

pleasant soft grip material for highest torque
angenehm griffiger Weichmantel für höchste Drehmomente



GS tested for safety
GS - geprüfte Sicherheit

The Original *Das Original* Serie 500

The leaders in *Führend in Design,*
handle-design *Ergonomie*
blade quality *Klingenqualität*
2-component- *2Komponentengriff-*
technology *Technik*

blades manufactured from chrome-molybdenum-vanadium steel

Klingen aus spezieller Chrom-Molybdän-Vanadium-Legierung

ergonomically refined design

ergonomisch ausgereiftes Design

superior torque which exceeds DIN and ISO requirements by up to 100%

Beste Leistungsdaten, bis zu 100% über DIN-Werten

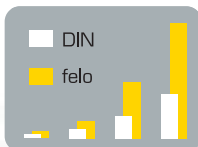

hanging hole for easy storage or inserting lever

Querloch: Zum Aufhängen der Werkzeuge oder zum Einstecken eines Hebels

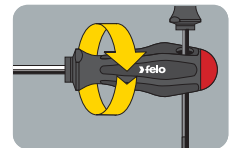
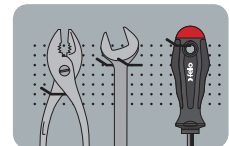
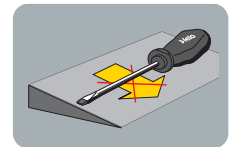

EAN code on every product

EAN-Code auf jedem Werkzeug



black tip for precision fit

Black-Tip für präzise Passung



500



|--|--|--|--|--|--|--|--|--|--|--|--|--|--|--|--|--|--|--|--|--|--|--|--|--|--|--|--|--|--|--|--|--|--|--|--|--|--|--|--|--|--|--|--|--|--|--|--|--|--|--|--|--|--|--|--|--|--|--|--|--|--|--|--|--|--|--|--|--|--|--|--|--|--|--|--|--|--|--|--|--|--|--|--|--|--|--|--|--|--|--|--|--|--|--|--|--|--|--|--|--|--|--|--|--|--|--|--|--|--|--|--|--|--|--|--|--|--|--|--|--|--|--|--|--|--|--|--|--|--|--|--|--|--|--|--|--|--|--|--|--|--|--|--|--|--|--|--|--|--|--|--|--|--|--|--|--|--|--|--|--|--|--|--|--|--|--|--|--|--|--|--|--|--|--|--|--|--|--|--|--|--|--|--|--|--|--|--|--|--|--|--|--|--|--|--|--|--|--|--|--|--|--|--|--|--|--|--|--|--|--|--|--|--|--|--|--|--|--|--|--|--|--|--|--|--|--|--|--|--|--|--|--|--|--|--|--|--|--|--|--|--|--|--|--|--|--|--|--|--|--|--|--|--|--|--|--|--|--|--|--|--|--|--|--|--|--|--|--|--|--|--|--|--|--|--|--|--|--|--|--|--|--|--|--|--|--|--|--|--|--|--|--|--|--|--|--|--|--|--|--|--|--|--|--|--|--|--|--|--|--|--|--|--|--|--|--|--|--|--|--|--|--|--|--|--|--|--|--|--|--|--|--|--|--|--|--|--|--|--|--|--|--|--|--|--|--|--|--|--|--|--|--|--|--|--|--|--|--|--|--|--|--|--|--|--|--|--|--|--|--|--|--|--|--|--|--|--|--|--|--|--|--|--|--|--|--|--|--|--|--|--|--|--|--|--|--|--|--|--|--|--|--|--|--|--|--|--|--|--|--|--|--|--|--|--|--|--|--|--|--|--|--|--|--|--|--|--|--|--|--|--|--|--|--|--|--|--|--|--|--|--|--|--|--|--|--|--|--|--|--|--|--|--|--|--|--|--|--|--|--|--|--|--|--|--|--|--|--|--|--|--|--|--|--|--|--|--|--|--|--|--|--|--|--|--|--|--|--|--|--|--|--|--|--|--|--|--|--|--|--|--|--|--|--|--|--|--|--|--|--|--|--|--|--|--|--|--|--|--|--|--|--|--|--|--|--|--|--|--|--|--|--|--|--|--|--|--|--|--|--|--|--|--|--|--|--|--|--|--|--|--|--|--|--|--|--|--|--|--|--|--|--|--|--|--|--|--|--|--|--|--|--|--|--|--|--|--|--|--|--|--|--|--|--|--|--|--|--|--|--|--|--|--|--|--|--|--|--|--|--|--|--|--|--|--|--|--|--|--|--|--|--|--|--|--|--|--|--|--|--|--|--|--|--|--|--|--|--|--|--|--|--|--|--|--|--|--|--|--|--|--|--|--|--|--|--|--|--|--|--|--|--|--|--|--|--|--|--|--|--|--|--|--|--|--|--|--|--|--|--|--|--|--|--|--|--|--|--|--|--|--|--|--|--|--|--|--|--|--|--|--|--|--|--|--|--|--|--|--|--|--|--|--|--|--|--|--|--|--|--|--|--|--|--|--|--|--|--|--|--|--|--|

Stubby



						Item No		EAN-Code
5,5 x 1,0	25	57	35	5,0	12	500 550 10	35	40 07157 22099 8
PZ 1	25	57	35	4,5	12	501 010 10	33	40 07157 22103 2
PZ 2	25	57	35	6,0	12	501 020 10	37	40 07157 22104 9
PH 1	25	57	35	4,5	12	502 010 10	33	40 07157 22109 4
PH 2	25	57	35	6,0	12	502 020 10	38	40 07157 22110 0

507



Torx TR						Item No		EAN-Code
10	100	80	25	3,5	12	507 103 40	33	40 07157 32234 0
15	100	90	29	4,0	12	507 153 40	47	40 07157 32236 4
20	100	99	34	5,0	12	507 203 40	69	40 07157 32238 8
25	100	99	34	5,0	12	507 253 40	68	40 07157 32240 1
27	100	99	34	5,0	12	507 273 40	70	40 07157 32242 5
30	115	105	39	6,0	6	507 303 40	98	40 07157 32244 9
40	125	105	39	8,0	6	507 404 40	130	40 07157 32246 3

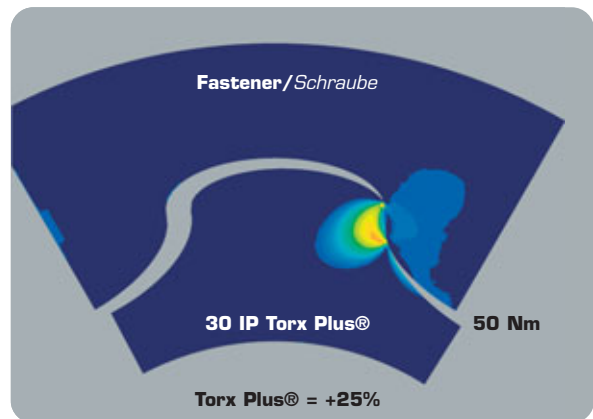
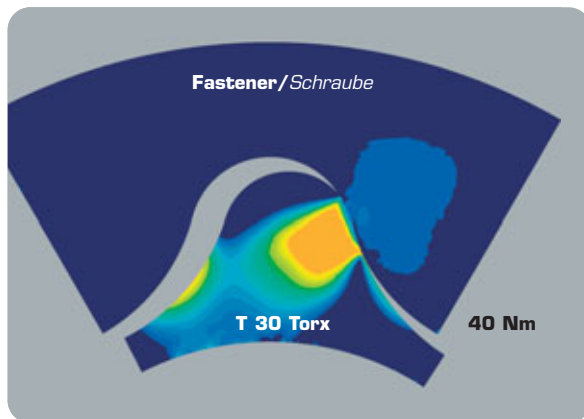

508



Torx						Item No		EAN-Code
5	60	68	20	3,0	12	508 051 40	15	40 07157 22188 9
6	60	68	20	3,0	12	508 061 40	15	40 07157 22154 4
7	60	80	25	3,0	12	508 071 40	28	40 07157 22156 8
8	60	80	25	3,0	12	508 083 40	28	40 07157 22157 5
9	60	80	25	3,5	12	508 093 40	28	40 07157 22158 2
10	100	80	25	3,5	12	508 103 40	33	40 07157 22159 9
15	100	90	29	4,0	12	508 153 40	48	40 07157 22160 5
20	100	99	34	5,0	12	508 203 40	69	40 07157 22161 2
25	100	99	34	5,0	12	508 253 40	69	40 07157 22162 9
27	100	99	34	5,0	12	508 273 40	70	40 07157 22163 6
30	115	105	39	6,0	6	508 303 40	96	40 07157 22164 3
40	125	105	39	8,0	6	508 404 40	129	40 07157 22165 0
45	125	105	39	8,0	6	508 454 40	129	40 07157 22166 7

509



Torx Plus						Item No		EAN-Code
IP 6	60	68	20	3,0	12	509 061 40	17	40 07157 51319 9
IP 7	60	80	25	3,0	12	509 071 40	28	40 07157 51321 2
IP 8	60	80	25	3,0	12	509 083 40	29	40 07157 51323 6
IP 9	60	80	25	3,0	12	509 093 40	30	40 07157 51325 0
IP 10	100	80	25	3,5	12	509 103 40	33	40 07157 51327 4
IP 15	100	90	29	4,0	12	509 153 40	48	40 07157 51329 8
IP 20	100	99	34	5,0	12	509 203 40	69	40 07157 51331 1
IP 25	100	99	34	5,0	12	509 253 40	69	40 07157 51333 5
IP 27	100	99	34	5,0	12	509 273 40	70	40 07157 51335 9
IP 30	115	105	39	6,0	6	509 303 40	97	40 07157 51337 3
IP 40	125	105	39	8,0	6	509 404 40	130	40 07157 51339 7

500



						Item No		EAN-Code
3,0 x 0,5	80	80	25	3,0	6	500 032 30	30	40 07157 51681 7
3,0 x 0,5	200	80	25	3,0	6	500 037 30	36	40 07157 51981 8
3,5 x 0,6	100	80	25	3,5	6	500 353 30	34	40 07157 51683 1
3,5 x 0,6	250	80	25	3,5	6	500 358 30	46	40 07157 51983 2
4,0 x 0,8	100	90	29	4,0	6	500 043 30	50	40 07157 51685 5
4,0 x 0,8	200	90	29	4,0	6	500 047 30	60	40 07157 51757 9

501



						Item No		EAN-Code
1	80	90	29	4,5	6	501 102 30	52	40 07157 51677 0
2	100	99	34	6,0	6	501 203 30	84	40 07157 51679 4
2	200	99	34	6,0	6	501 207 30	108	40 07157 51759 3

502



						Item No		EAN-Code
1	80	90	29	4,5	6	502 102 30	50	40 07157 51673 2
1	200	90	29	4,5	6	502 107 30	68	40 07157 51985 6
2	100	99	34	6,0	6	502 203 30	84	40 07157 51675 6
2	200	99	34	6,0	6	502 207 30	106	40 07157 51761 6

508



						Item No		EAN-Code
10	100	80	25	3,5	6	508 103 30	34	40 07157 51665 7
15	100	90	29	4,0	6	508 153 30	50	40 07157 51667 1
20	100	99	34	5,0	6	508 203 30	72	40 07157 51669 5
25	100	99	34	5,0	6	508 253 30	73	40 07157 51671 8

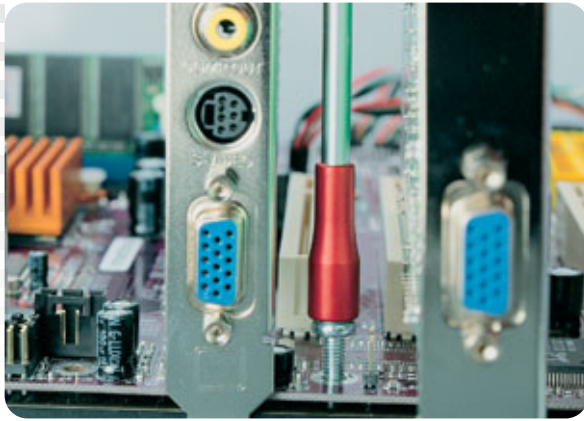

520



4,0 x 0,8	155	90	29	4,0	6	
5,5 x 1,0	155	99	34	5,5	6	

Item No



EAN-Code

520 045 10

66

40 07157 50072 4

520 055 10

92

40 07157 50074 8

522

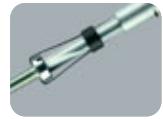

PH						
1	155	90	29	4,0	6	
2	155	99	34	5,5	6	

Item No



EAN-Code

522 105 10

66

40 07157 50076 2

522 205 10

91

40 07157 50078 6

538

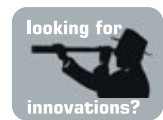

Star-					
100	100	99	34		6

Item No



EAN-Code

538 100 40

102

40 07157 51397 7

Automatikhalter 1/4"

527



mm						Item No		EAN-Code
2	75	80	25	2,0	12	527 202 40	26	40 07157 22167 4
2,5	100	80	25	2,5	12	527 253 40	29	40 07157 22168 1
3	100	80	25	3,0	12	527 303 40	32	40 07157 22169 8
4	100	90	29	4,0	12	527 403 40	50	40 07157 22170 4
5	100	99	34	5,0	12	527 503 40	72	40 07157 22171 1
6	125	99	34	6,0	12	527 604 40	90	40 07157 22178 0
8	150	105	39	8,0	12	527 805 40	149	40 07157 22173 5

528



mm						Item No		EAN-Code
4	125	90	29		12	528 040 40	63	40 07157 22174 2
5	125	90	29		12	528 050 40	64	40 07157 22175 9
5,5	125	90	29		12	528 055 40	64	40 07157 22176 6
5,5	200	90	29		12	528 058 40	76	40 07157 50769 3
6	125	90	29		12	528 060 40	66	40 07157 22177 3
6	250	90	29		12	528 068 40	85	40 07157 22189 6
7	125	99	34		12	528 070 40	95	40 07157 22179 7
7	250	99	34		12	528 078 40	123	40 07157 22180 3
8	125	99	34		12	528 080 40	97	40 07157 22181 0
9	125	99	34		12	528 090 40	97	40 07157 22182 7
10	125	99	34		12	528 100 40	101	40 07157 22183 4
11	125	105	39		12	528 110 40	151	40 07157 22184 1
12	125	105	39		12	528 120 40	154	40 07157 22185 8
13	125	105	39		12	528 130 40	156	40 07157 22186 5
14	125	105	39		12	528 140 40	156	40 07157 22187 2

538



1/4"						Item No		EAN-Code
1/4"	100	99	34		6	538 125 40	102	40 07157 32348 4

500



	Item No		EAN-Code
Set 6-pcs / Satz 6-tlg	500 961 17	570	40 07157 50174 5
(4 x) 500:	3,5 x 100 / 4,0 x 100 / 5,5 x 125 / 6,5 x 150		
(2 x) 502:	PH 1 x 80 / PH 2 x 100		

500



	Item No		EAN-Code
Set 6-pcs / Satz 6-tlg	500 963 17	590	40 07157 51311 3
(2 x) 500:	4,0 x 100 / 6,5 x 150		
(2 x) 501:	PZ 1 x 80 / PZ 2 x 100		
(2 x) 502:	PH 1 x 80 / PH 2 x 100		

508



	Item No		EAN-Code
Set 6-pcs / Satz 6-tlg	508 961 47	642	40 07157 50178 3
(6 x) 508:	Torx 10 / Torx 15 / Torx 20 / Torx 25 Torx 30 / Torx 40		

508



Item No



EAN-Code

Set 7-pcs / Satz 7-tlg

508 971 47

558

40 07157 50705 1

(7 x) 508: Torx 6 / Torx 8 / Torx 10 / Torx 15 / Torx 20
Torx 25 / Torx 30

500



Item No



EAN-Code

Set 7-pcs / Satz 7-tlg

500 971 37

522

40 07157 51699 2

(3 x) 500: 3,0 x 80 / 3,5 x 100 / 4,0 x 100
(2 x) 502: PH 1 x 80 / PH 2 x 100
(2 x) 508: Torx 10 x 100 / Torx 15 x 100

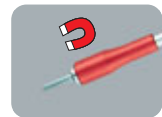

500



Item No



EAN-Code

Set 3-pcs / Satz 3-tlg

500 933 34

266

40 07157 51857 6

(1 x) 500: 4,0 x 200
(2 x) 502: PH 1 x 80 / PH 2 x 200

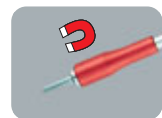

508



Set 3-pcs / Satz 3-tlg

[3 x] 508: Torx 10 / Torx 15 / Torx 20

Item No

508 931 34



204

EAN-Code

40 07157 51855 2

500



Set 3-pcs / Satz 3-tlg

[1 x] 500: 4,0 x 300

[1 x] 501: PZ 2 x 300

[1 x] 502: PH 2 x 300

Item No

500 931 14



363

EAN-Code

40 07157 51775 3

500



Set 3-pcs / Satz 3-tlg

500: 5,5 x 125 / 6,5 x 150

502: PH 2 x 100

Item No

500 934 14



292

EAN-Code

40 07157 53707 2

500



Set 5-pcs / Satz 5-tlg

[3 x] 500: 4,0 x 100 / 5,5 x 125 / 6,5 x 150

[2 x] 502: PH 1 x 80 / PH 2 x 100

Item No

500 951 18



452

EAN-Code

40 07157 22062 2

500



Item No



EAN-Code

Set 7-pcs / Satz 7-tlg

500 971 18

552

40 07157 22134 6

(4 x) **500**: 3,5 x 100 / 4,0 x 100 / 5,5 x 125 / 6,5 x 150

(1 x) **501**: PZ 2 x 100

(2 x) **502**: PH 1 x 80 / PH 2 x 100

507



Item No



EAN-Code

Set 6-pcs / Satz 6-tlg

507 961 48

548

40 07157 50823 2

(6 x) **507**: Torx TR 10 / Torx TR 15 / Torx TR 20 / Torx TR 25 /

Torx TR 30 / Torx TR 40

500



Item No



EAN-Code

Promo Pack 500 / 513 VDE (440 mm / 325 mm / 305 mm)

500 924 00

10654

40 07157 51439 4

(16 x)

500 951 18

(3 x) **500**: 4,0 x 100 / 5,5 x 125 / 6,5 x 150

(2 x) **502**: PH 1 x 80 / PH 2 x 100

(8 x)

513 951 98

(4 x) **513**: 3,0 x 100 / 3,5 x 100 / 4,0 x 100 / 5,5 x 125

(1 x) **515**: PZ 2 x 100



AC 1000V
IEC 60900 : 2004



30



AC 1000V
IEC 60900 : 2004





500



	Item No		EAN-Code
toolcase 12-pcs / Koffer 12-tlg.	500 112 16	1216	40 07157 22138 4
(5 x) 500:	5,5 x 25 / 3,5 x 100 / 4,0 x 100 / 5,5 x 125 / 6,5 x 150		
(1 x) 550:	8,0 x 155 		
(3 x) 501:	PZ 0 x 60 / PZ 1 x 80 / PZ 2 x 100		
(3 x) 502:	PH 0 x 60 / PH 1 x 80 / PH 2 x 100		

500



	Item No		EAN-Code
toolcase 11-pcs / Koffer 11-tlg.	500 111 16	964	40 07157 32558 7
(4 x) 500:	4,0 x 100 / 5,5 x 25 / 5,5 x 125 / 6,5 x 150		
(1 x) 501:	PZ 2 x 100		
(3 x) 502:	PH 1 x 80 / PH 2 x 25 / PH 2 x 100		
(2 x) 613:	2,5 x 75 / 3,5 x 100    AC 1000V IEC 60900 : 2004		
(1 x) 361:	Mains testing screwdriver / Spannungsprüfer VDE 0680/6, 220-250 Volt		

500



	Item No		EAN-Code
toolcase 5-pcs / Koffer 5-tlg.	500 951 16	1074	40 07157 50112 7
(2 x) 500:	4,0 x 100 / 5,5 x 125		
(1 x) 502:	PH 2 x 100		
(1 x) 590:	Combination Pliers / 2K Kombizange 180 mm		
(1 x) 591:	Diagonal Knippers / 2K Seitenschneider 160 mm		

handles manufactured from shock-proof polypropylene

Griffe aus schlagfestem Polypropylen

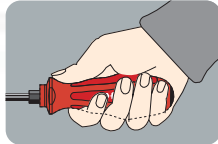

ergonomically refined design

ergonomisch ausgereiftes Design

steelcap

Stahl-Schlagkappe

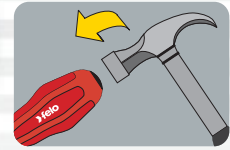

The strongest of series 200
Die Stärksten aus der Serie 200

Serie 206

steelcap / Stahl-Schlagkappe

full length blade / durchgehende Klinge

hexagon bolster / Schlüsselhilfe

hexagon blade / Sechskantklinge

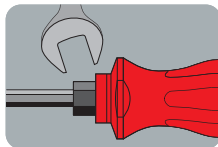

hexagon bolster

Schlüsselhilfe

anti-roll handle design

Griffkopf mit Abrollschutz

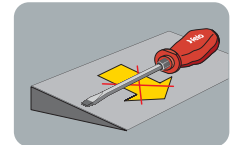

hexagon blades manufactured from chrome-molybdenum-vanadium steel

Sechskantklingen aus spezieller Chrom-Molybdän-Vanadium-Legierung



GS tested for safety

GS - geprüfte Sicherheit



EAN code on every product

EAN-Code auf jedem Werkzeug

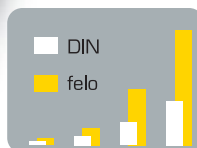

superior torque which exceeds DIN and ISO requirements by up to 100%

Beste Leistungsdaten, bis zu 100% über DIN-Werten

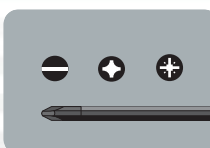

black tip for precision fit

Black-Tip für präzise Passung



full length blade

Durchgehende Klinge

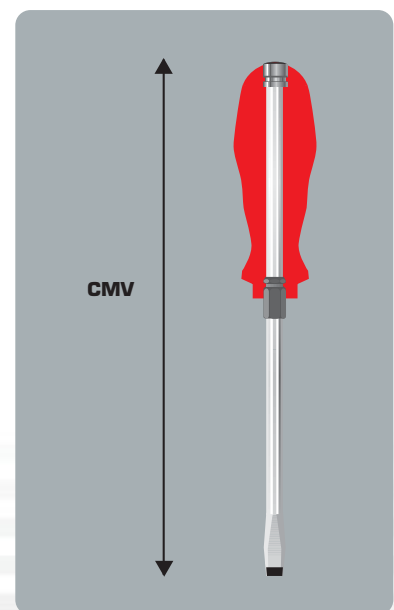

206

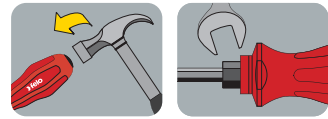

								Item No		EAN-Code
5,5 x 1,0	100	98	34	5,0	12		206 055 90	94	40 07157 31690 5	
6,5 x 1,2	125	98	34	6,35	12		206 065 90	120	40 07157 24036 1	
8,0 x 1,2	150	105	38	8,0	6		206 080 90	195	40 07157 30876 4	
10,0 x 1,6	175	105	38	8,0	6		206 100 90	204	40 07157 13166 9	
12,0 x 2,0	200	105	38	10,0	6		206 120 90	286	40 07157 31692 9	

216



PZ								Item No		EAN-Code
2	100	98	34	6,35	12		216 203 90	115	40 07157 31694 3	
3	150	105	38	8,0	6		216 305 90	195	40 07157 31696 7	

226

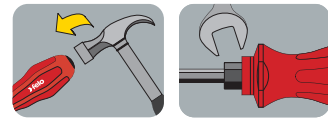

PH								Item No		EAN-Code
2	100	98	34	6,35	12		226 203 90	115	40 07157 31698 1	
3	150	105	38	8,0	6		226 305 90	194	40 07157 31700 1	

206

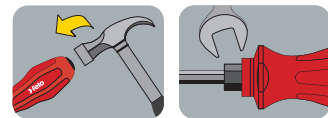

								Item No		EAN-Code
Set 5-pcs / Satz 5-tlg.							206 951 98	838	40 07157 31720 9	
(3 x)	206:	5,5 x 100 / 6,5 x 125 / 8,0 x 150								
(2 x)	226:	PH 2 x 100 / PH 3 x 150								

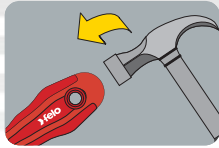

handles manufactured from shock-proof polypropylene

Griffe aus schlagfestem Polypropylen

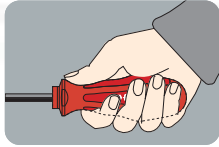

ergonomically refined design

ergonomisch ausgereiftes Design



GS tested for safety

GS - geprüfte Sicherheit



High quality and comprehensive range Serie 200

*Überragend in Qualität,
Preis und Vielfalt*

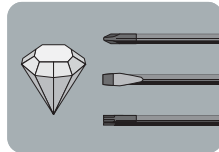

blades manufactured from chrome-molybdenum-vanadium steel

Klingen aus spezieller Chrom-Molybdän-Vanadium-Legierung

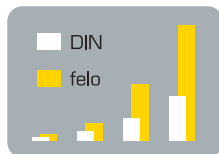

superior torque which exceeds DIN and ISO requirements by up to 100%

Beste Leistungsdaten, bis zu 100% über DIN-Werten

anti-roll handle design

Griffkopf mit Abrollschutz

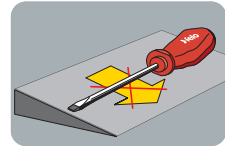

hanging hole for easy storage or inserting lever

*Querloch:
Zum Aufhängen der Werkzeuge
oder zum Einstecken eines Hebels*

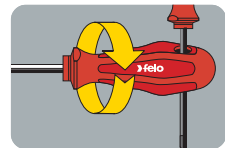
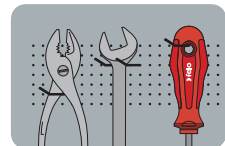

EAN code on every product

EAN-Code auf jedem Werkzeug



black tip for precision fit

Black-Tip für präzise Passung

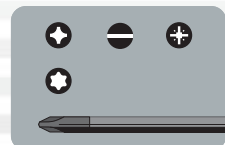

200



								Item No		EAN-Code
2,5 x 0,4	75	80	25	2,5	12			200 022 90	24	40 07157 13001 3
3,0 x 0,5	80	80	25	3,0	12			200 032 90	26	40 07157 13003 7
3,5 x 0,6	100	80	25	3,5	12			200 353 90	30	40 07157 13035 8
4,0 x 0,8	100	90	29	4,0	12			200 043 90	43	40 07157 13010 5
5,0 x 0,8	125	90	29	5,0	12			200 054 90	55	40 07157 13016 7
5,5 x 1,0	125	98	34	5,0	12			200 554 90	68	40 07157 13041 9
6,5 x 1,2	125	98	34	6,0	12			200 654 90	79	40 07157 16050 8
6,5 x 1,2	150	98	34	6,0	12			200 655 90	85	40 07157 13051 8
8,0 x 1,2	175	105	38	7,0	12			200 086 90	122	40 07157 13028 0
10,0 x 1,6	200	105	38	8,0	6			200 107 90	151	40 07157 13032 7

201



PZ								Item No		EAN-Code
0	60	80	25	3,0	12			201 001 90	25	40 07157 13076 1
1	80	90	29	4,5	12			201 102 90	44	40 07157 13081 5
2	100	98	34	6,0	12			201 203 90	75	40 07157 13084 6
3	150	105	38	8,0	6			201 305 90	134	40 07157 13089 1

202



PH								Item No		EAN-Code
0	60	80	25	3,0	12			202 001 90	24	40 07157 13099 0
1	80	90	29	4,5	12			202 102 90	44	40 07157 13106 5
2	100	98	34	6,0	12			202 203 90	75	40 07157 13111 9
3	150	105	38	8,0	6			202 305 90	131	40 07157 13117 1

Stubby



							Item No		EAN-Code
5,5 x 1,0	25	58	33	5,0	12		200 550 90	30	40 07157 13037 2
6,5 x 1,2	25	58	33	6,0	12		200 650 90	34	40 07157 13045 7
PZ 2	25	58	33	6,0	12		201 020 90	34	40 07157 13079 2
PH 2	25	58	33	6,0	12		202 020 90	34	40 07157 13103 4

208



Torx						Item No		EAN-Code
6	60	80	25	3,0	12	208 061 90	23	40 07157 31332 4
7	60	80	25	3,0	12	208 071 90	25	40 07157 31333 1
8	60	80	25	3,0	12	208 083 90	25	40 07157 31334 8
9	60	80	25	3,5	12	208 093 90	24	40 07157 31335 5
10	100	90	29	3,5	12	208 103 90	39	40 07157 31336 2
15	100	90	29	4,0	12	208 153 90	43	40 07157 31337 9
20	100	98	34	5,0	12	208 203 90	64	40 07157 31338 6
25	100	98	34	5,0	12	208 253 90	65	40 07157 31339 3
27	100	98	34	5,0	12	208 273 90	64	40 07157 31340 9
30	115	105	38	6,0	6	208 303 90	91	40 07157 31341 6
40	125	105	38	8,0	6	208 404 90	123	40 07157 31342 3

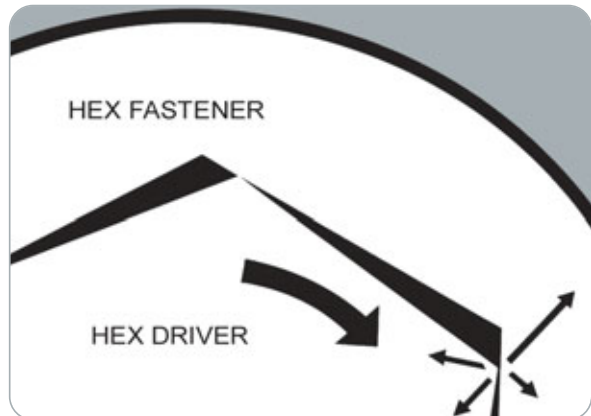
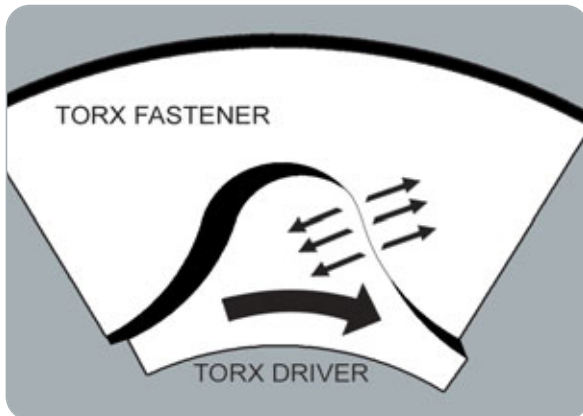

290



ESD Safe
10⁸ - 10¹⁰ Ω



Item No	Length	Blade Length	Blade Width	Blade Thickness	Handle Diameter	Handle Length	Handle Shape
290 353 90	100	80	25	3,5	6	6	[Icon]
290 043 90	100	90	29	4,0	6	6	[Icon]
290 554 90	125	98	34	5,0	6	6	[Icon]
290 655 90	150	98	34	6,0	6	6	[Icon]
290 656 90	200	98	34	6,0	6	6	[Icon]

Item No	Quantity	EAN-Code
290 353 90	35	40 07157 50282 7
290 043 90	51	40 07157 50284 1
290 554 90	79	40 07157 50286 5
290 655 90	96	40 07157 50288 9
290 656 90	100	40 07157 51901 6

292



ESD Safe
10⁸ - 10¹⁰ Ω

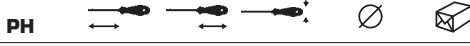

PH	Length	Blade Length	Blade Width	Blade Thickness	Handle Diameter	Handle Length	Handle Shape
0	60	80	25	3,0	6	6	[Icon]
1	80	90	29	4,5	6	6	[Icon]
2	100	98	34	6,0	6	6	[Icon]
2	150	98	34	6,0	6	6	[Icon]
2	200	98	34	6,0	6	6	[Icon]

Item No	Quantity	EAN-Code
292 001 90	30	40 07157 50290 2
292 102 90	52	40 07157 50292 6
292 203 90	85	40 07157 50294 0
292 205 90	96	40 07157 51905 4
292 207 90	108	40 07157 51903 0

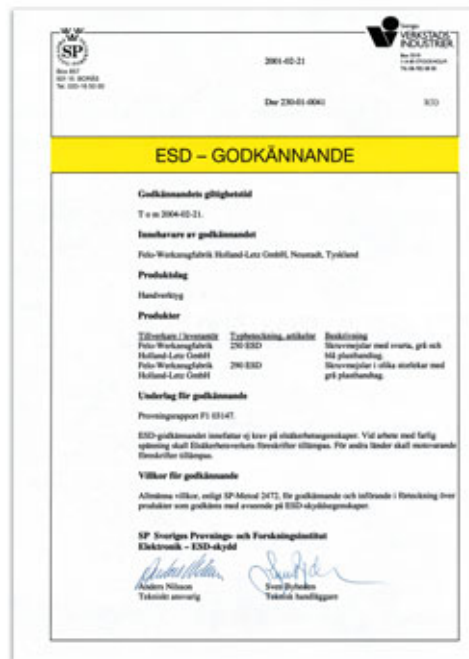

200



	Item No		EAN-Code
Set 5-pcs / Satz 5-tlg	200 951 98	374	40 07157 16052 2
(3 x) 200:	3,5 x 100 / 4,0 x 100 / 5,5 x 125		
(2 x) 202:	PH 1 x 80 / PH 2 x 100		

200



	Item No		EAN-Code
Set 7-pcs / Satz 7-tlg	200 972 98	564	40 07157 16054 6
(5 x) 200:	3,5 x 100 / 4,0 x 100 / 5,5 x 125 6,5 x 150 / 8,0 x 175		
(2 x) 202:	PH 1 x 80 / PH 2 x 100		

200



	Item No		EAN-Code
Set 7-pcs / Satz 7-tlg	200 973 98	554	40 07157 16055 3
(4 x) 200:	3,0 x 80 / 4,0 x 100 / 5,5 x 125 / 8,0 x 175		
(1 x) 201:	PZ 2 x 100		
(2 x) 202:	PH 1 x 80 / PH 2 x 100		

208



Item No



EAN-Code

Set 7-pcs / Satz 7-tlg

208 971 98

548

40 07157 50468 5

(7 x) 208: Torx 8 / Torx 10 / Torx 15 / Torx 20
Torx 25 / Torx 30 / Torx 40

200



Item No



EAN-Code

Set 7-pcs / Satz 7-tlg

200 971 97

548

40 07157 50108 0

(3 x) 200: 4,0 x 0,8 / 5,5 x 1,0 / 6,5 x 1,2

(2 x) 202: PH 1 x 80 / PH 2 x 100

(1 x) 613: 3,5 x 0,6 AC 1000V
IEC 60900 : 2004

(1 x) 361: Mains testing screwdriver / Spannungsprüfer

VDE 0680/6, 220-250 Volt



200



Item No



EAN-Code

Set 7-pcs / Satz 7-tlg

200 972 97

552

40 07157 50156 1

(3 x) 200: 4,0 x 0,8 / 5,5 x 1,0 / 6,5 x 1,2

(2 x) 201: PZ 1 x 80 / PZ 2 x 100

(1 x) 613: 3,5 x 0,6 AC 1000V
IEC 60900 : 2004

(1 x) 361: **Mains testing screwdriver / Spannungsprüfer**
VDE 0680/6, 220-250 Volt



200



Item No



EAN-Code

toolcase 12-pcs / Koffer 12-tlg.

200 112 96

1158

40 07157 22152 0

(4 x) 200: 6,5 x 25 / 4,0 x 100 / 5,5 x 125 / 6,5 x 150

(2 x) 201: PZ 1 x 80 / PZ 2 x 100

(3 x) 202: PH 0 x 60 / PH 1 x 80 / PH 2 x 100

(1 x) 206: 8,0 x 150

(1 x) 613: 3,5 x 100 AC 1000V
IEC 60900 : 2004

(1 x) 361: **Mains testing screwdriver / Spannungsprüfer**
VDE 0680/6, 220-250 Volt

200



Item No



EAN-Code

	Item No		EAN-Code
toolcase 12-pcs / Koffer 12-tlg.	200 114 96	1163	40 07157 32506 8
(4 x) 200: 4,0 x 100 / 5,5 x 25 / 5,5 x 125 / 6,5 x 150			
(1 x) 201: PZ 2 x 100			
(1 x) 202: PH 2 x 100			
(1 x) 206: 8,0 x 150			
(3 x) 613: 2,5 x 75 / 3,5 x 100 / 4,0 x 100		AC 1000V IEC 60900 : 2004	
(1 x) 614: PH 1 x 80		AC 1000V IEC 60900 : 2004	
(1 x) 361: Mains testing screwdriver / Spannungsprüfer VDE 0680/6, 220-250 Volt			



Leather cap to protect against splintering

Lederkappe als Splitterschutz

full length blade

Durchgehende Klinge

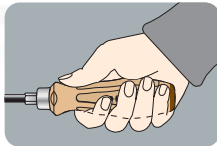
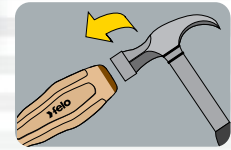

ergonomic handle

ergonomische, ballige Griffkontur

Handle made of hard beechwood

Griff aus besonderem Buche-Hartholz

Commitment to fine, traditional hand tools Serie 330

Handwerklicher Tradition verpflichtet

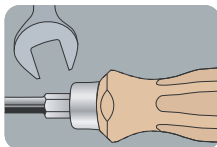

Forged hexagon bolster

Angeschmiedeter Sechskant als Schlüsselhilfe

anti-roll handle design

Griffkopf mit Abrollschutz

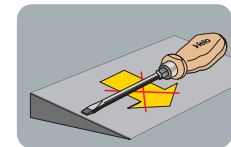

blades manufactured from chrome-molybdenum-vanadium steel

Klingen aus spezieller Chrom-Molybdän-Vanadium-Legierung



full length blade

durchgehende Klinge, schlagfest

superior torque which exceeds DIN and ISO requirements by up to 100%

Beste Leistungsdaten, bis zu 100% über DIN-Werten

EAN code on every product

EAN-Code auf jedem Werkzeug

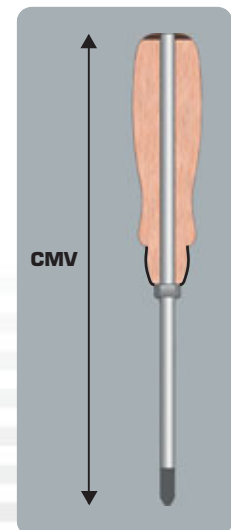

Chrome-plated blade with black tip

Mattverchromt mit Black-Tip

335

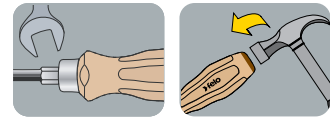

								Item No		EAN-Code
3,5 x 0,6	75	95	24	4,5	12		335 035 90	47	40 07157 18031 5	
4,5 x 0,8	90	95	24	4,5	12		335 045 90	55	40 07157 18032 2	
5,5 x 1,0	100	100	24	5,5	12		335 055 90	72	40 07157 18036 0	
7,0 x 1,2	125	110	30	6,0	12		335 065 90	113	40 07157 18040 7	
9,0 x 1,2	150	120	32	8,0	12		335 080 90	160	40 07157 18043 8	
10,0 x 1,6	175	125	34	9,0	6		335 100 90	184	40 07157 18047 6	
12,0 x 2,0	200	125	34	9,0	6		335 120 90	232	40 07157 18050 6	

336

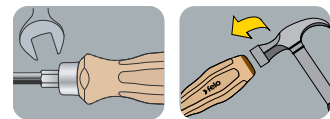

								Item No		EAN-Code
PZ 1	80	95	24	4,5	12		336 102 90	47	40 07157 18060 5	
2	100	110	30	6,0	12		336 203 90	88	40 07157 18061 2	
3	150	120	32	8,0	6		336 305 90	163	40 07157 18062 9	

337

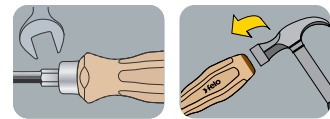

								Item No		EAN-Code
PH 1	80	95	24	4,5	12		337 102 90	45	40 07157 18063 6	
2	100	110	30	6,0	12		337 203 90	88	40 07157 18067 4	
3	150	120	32	8,0	6		337 305 90	164	40 07157 18071 1	



335



	Item No		EAN-Code
Set 5-pcs / Satz 5-tlg	335 951 98	592	40 07157 22155 1
(3 x) 335:	5,5 x 100 / 7,0 x 125 / 9,0 x 150		
(2 x) 337:	PH 1 x 80 / PH 2 x 100		

335



	Item No		EAN-Code
Set 7-pcs / Satz 7-tlg	335 971 98	714	40 07157 18108 4
(4 x) 335:	4,5 x 90 / 5,5 x 100 / 7,0 x 125 / 9,0 x 150		
(2 x) 337:	PH 1 x 80 / PH 2 x 100		
(1 x) 336:	PZ 2 x 100		



490



Awl / Rundahle

60 mm 60 32 4 mm 12

Item No



EAN-Code

490 041 10

36

40 07157 31078 1

493



Awl / Rundahle

100 mm 80 34 6 mm 12

Item No



EAN-Code

493 063 10

72

40 07157 23006 5

498



Reamer / Aufreiber

100 mm 80 34 6 mm 12

Item No



EAN-Code

498 063 10

73

40 07157 23013 3

494



Tacklifter / Reißzweckenheber

100 mm 80 34 12

Item No



EAN-Code

494 003 30

75

40 07157 24022 4

326



Reversible-Blade Screwdriver

12

Item No



EAN-Code

326 965 10

55

40 07157 31068 2

Umsteckschraubendreher

5,5 - PH 2 x 60 mm

dto. on card / auf Karte

12

326 965 11

66

40 07157 18104 6

12 interchangeable IEC screwdriver blades with 2-component handle in sturdy smart box

12 IEC Wechselklingen mit 2-Komponenten-Griff in robuster smart Box

every screwdriver individually tested to 10.000 Volts, fully conforming to DIN EN 60900

Sicherheitswerkzeug nach DIN ISO 60900 – alle Schraubendreher stückgeprüft mit 10.000 Volt

**AC 1000V
IEC 60900 : 2004**



secure fit of blades, quick-release button on handle against unwanted extraction

sicherer Halt der Klingen im Griff, automatische Verriegelung gegen ungewolltes Herausziehen



The first compact smart tool for electricians.
Esmart (pat.)

Das erste kompakte smart-Werkzeug für Elektriker.



precision cap and soft-grip zone on blades for low torque application

aufsteckbare Drehkappe und Weichmantelzone für Einsatz als Feinwerkzeuge



063



AC 1000V
IEC 60900 : 2004



		Item No		EAN-Code
Felo E-SMART	Box 14-pce / Box 14-tlg.	063 913 06	984	40 07157 51719 7
(12 x)	Blade / Klinge			
	2,5 x 0,4 / 3,0 x 0,5 / 3,5 x 0,6 / 4,0 x 0,8 / 5,5 x 1,0 / 6,5 x 1,2			
	PH 1 / PH 2			
	PZ 2			
	Torx 10 / Torx 15 / Torx 20			
(1 x)	Handle / Griff 95 x 32 mm			
(1 x)	Precision Cap / Drehkappe			
	StrongBox 230mm x 130mm x 56mm			

063



AC 1000V
IEC 60900 : 2004



		Item No		EAN-Code
Felo E-SMART	Box in Blister Box 14-pce / Box 14-tlg.	063 913 01	1044	40 07157 53077 6
(12 x)	Blade / Klinge			
	2,5 x 0,4 / 3,0 x 0,5 / 3,5 x 0,6 / 4,0 x 0,8 / 5,5 x 1,0 / 6,5 x 1,2			
	PH 1 / PH 2			
	PZ 2			
	Torx 10 / Torx 15 / Torx 20			
(1 x)	Handle / Griff 95 x 32 mm			
(1 x)	Precision Cap / Drehkappe			
	StrongBox 230mm x 130mm x 56mm			



AC 1000V
IEC 60900 : 2004







063



	Item No		EAN-Code
Felo E-SMART Industry Box 14-pce / Box 14-tlg.	063 913 16	1071	40 07157 53263 3
{10 x} Blade / Klinge			
	2,5 x 0,4 / 3,0 x 0,5 / 3,5 x 0,6 / 4,0 x 0,8 / 5,5 x 1,0 / 6,5 x 1,2		
	PH 1 / PH 2 / PZ 2 / Z 2		
{1 x} Bit: Spanner 10 x 25			
{1 x} Universal Cabinet key / Schaltschrankschlüssel			
{1 x} Handle / Griff 95 x 32 mm			
{1 x} Precision Cap / Drehkappe			
StrongBox 230mm x 130mm x 56mm			



Universal Cabinet key /
Schaltschrankschlüssel

- 1 x 
- 1 x 
- 3 x 
- 1 x 

063

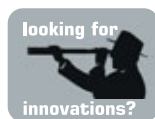

AC 1000V
IEC 60900 : 2004



	Item No		EAN-Code
Zip-Bag 19-pcs/ Reissverschlussstasche 19-tlg.	063 919 04	1550	40 07157 60353 1
(14 x) Blade / Klinge			
	2,5 x 0,4 / 3,0 x 0,5 / 3,5 x 0,6 / 4,0 x 0,8 / 5,5 x 1,0 / 6,5 x 1,2		
	PH 1 / PH 2		
	PZ 2		
	Torx 10 / Torx 15 / Torx 20		
	H 2		
	Z 2		
(1 x) Handle / Griff 95 x 32 mm			
(1 x) Precision Cap / Drehkappe			
(1 x) Combination Pliers / Kombizange 180 mm			
(1 x) Diagonal Nippers / Seitenschneider 160 mm			
(1 x) Mains testing Screwdriver / Spannungsprüfer 3,0 mm x 70 mm			
	(VDE 0680/6, 150-250 Volt)		
Nylon bag / Nylon Tasche 310 mm, 190 mm, 70 mm			

VDE Klagen für die Serie Nm

stückgeprüft nach EN 60900:2004

VDE blades for Series Nm

Individually tested according EN 60900:2004



AC 1000V
IEC 60900 : 2004



108



Nm VDE		Nm max			Item No		EAN-Code
3,5 x 0,6	170		1/4"	1	100 353 14	23	40 07157 61651 7
4,0 x 0,8	170		1/4"	1	100 043 14	24	40 07157 61653 1
5,5 x 1,0	170		1/4"	1	100 554 14	26	40 07157 61655 5
PH1	170		1/4"	1	102 102 14	26	40 07157 61657 9
PH2	170		1/4"	1	102 203 14	31	40 07157 61659 3
PZ1	170		1/4"	1	101 102 14	26	40 07157 61661 6
PZ2	170		1/4"	1	101 203 14	31	40 07157 61663 0
H2 +/-	170		1/4"	1	106 203 14	31	40 07157 61665 4
Z2 +/-	170		1/4"	1	107 203 14	31	40 07157 61667 8



Ergonic, the first handle that adapts to the user's hand!

Ergonic, der erste Griff, der sich der Hand anpasst!



smooth, seamless handle for maximum comfort

nahtfrei glatte Kappe für minimale Reibung

hand and handle interlock, causing less strain

Hand und Griff verzahnen sich – der Kraftaufwand sinkt

stronger / stärker

adaptable / anpassungsfähig

truly ergonomic / wirklich ergonomisch

VDE

Serie 400 **ERGONIC**® (pat.)

**AC 1000V
IEC 60900 : 2004**



blades manufactured from chrome-molybdenum-vanadium steel

Klingen aus spezieller Chrom-Molybdän-Vanadium-Legierung

hanging hole for easy storage or inserting lever

Querloch: Zum Aufhängen der Werkzeuge oder zum Einstecken eines Hebels

anti-roll handle design

Griffkopf mit Abrollschutz

screw symbols on handle cap

Schraubensymbole auf Griffkappe



GS tested for safety

GS – geprüfte Sicherheit



EAN code on every product

EAN-Code auf jedem Werkzeug



full length, impact proof handle core

durchgehender, schlagfester Hartkern



black tip for precision fit

Black-Tip zur Erhaltung der Präzision und Passgenauigkeit

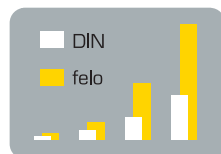

superior torque which exceeds DIN and ISO requirements by up to 100%

Beste Leistungsdaten, bis zu 100% über DIN-Werten

413



AC 1000V
IEC 60900 : 2004



							Item No		EAN-Code
2,5 x 0,4	75	86	25	2,5	12		413 025 90	28	40 07157 53133 9
3,0 x 0,5	100	86	25	3,0	12		413 030 90	32	40 07157 53135 3
3,5 x 0,6	100	86	25	3,5	12		413 035 90	34	40 07157 53139 1
3,5 x 0,8	100	86	25	3,5	12		413 038 90	34	40 07157 61731 6
4,0 x 0,8	100	94	30	3,5	12		413 040 90	46	40 07157 53141 4
4,5 x 1,0	125	101	33	4,5	12		413 045 90	69	40 07157 53143 8
5,5 x 1,0	125	101	33	4,5	12		413 055 90	68	40 07157 53145 2
6,5 x 1,2	150	106	36	5,5	6		413 065 90	100	40 07157 53147 6
8,0 x 1,2	175	112	39	7,0	6		413 080 90	140	40 07157 53149 0

414



AC 1000V
IEC 60900 : 2004

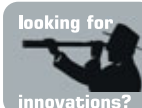

PH							Item No		EAN-Code
0	60	86	25	3,0	12		414 001 90	29	40 07157 53151 3
1	80	94	30	5,0	12		414 102 90	51	40 07157 53153 7
2	100	106	36	6,0	12		414 203 90	94	40 07157 53155 1
3	150	112	39	8,0	6		414 304 90	150	40 07157 53157 5

415



AC 1000V
IEC 60900 : 2004

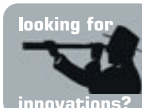

PZ							Item No		EAN-Code
1	80	94	30	5,0	12		415 102 90	51	40 07157 53159 9
2	100	106	36	6,0	12		415 203 90	94	40 07157 53161 2
3	150	112	39	8,0	6		415 304 90	151	40 07157 53163 6



416



Plus/Minus	↔	↔	↔	∅	📦
H1	80	94	30	5,0	12
H2	100	106	36	6,0	12

AC 1000V
IEC 60900 : 2004



Item No	📦	EAN-Code
416 102 90	51	40 07157 60311 1
416 203 90	94	40 07157 60313 5

417



Plus/Minus	↔	↔	↔	∅	📦
Z1	80	94	30	5,0	12
Z2	100	106	36	6,0	12

AC 1000V
IEC 60900 : 2004



Item No	📦	EAN-Code
417 102 90	51	40 07157 60315 9
417 203 90	94	40 07157 60317 3

418



Torx®	↔	↔	↔	∅	📦
10	100	86	25	3,5	12
15	100	94	30	3,5	12
20	125	101	33	4,5	12
25	125	106	36	4,5	12
30	150	112	39	6,0	6

AC 1000V
IEC 60900 : 2004



Item No	📦	EAN-Code
418 103 90	37	40 07157 60369 2
418 153 90	54	40 07157 60371 5
418 203 90	76	40 07157 60373 9
418 253 90	84	40 07157 60375 3
418 303 90	118	40 07157 60377 7

419



M-TEC



MTec	↔	↔	↔	∅	📦
5,5	110	94	30		12
6	110	94	30		12
7	110	94	30		12
8	110	101	33		12
10	125	101	33		12
13	125	106	36		12

AC 1000V
IEC 60900 : 2004



Item No	📦	EAN-Code
419 055 30	103	40 07157 60297 8
419 060 30	104	40 07157 60351 7
419 070 30	114	40 07157 60299 2
419 080 30	133	40 07157 60301 2
419 100 30	140	40 07157 60303 6
419 130 30	237	40 07157 60305 0

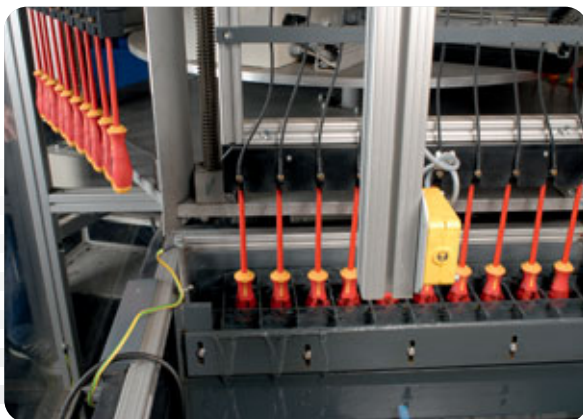

100% testing (10.000 V)



+ 5 additional tests on every material lot

+ 5 weitere Tests bei jeder Materialcharge

413



AC 1000V
IEC 60900 : 2004



Item No

413 931 94



254

EAN-Code

40 07157 53175 9

Set 3-pcs VDE / Satz 3-tlg.

(2 x) 413: 4,0 x 100 / 5,5 x 125

(1 x) 414: PH 2 x 100

413



AC 1000V
IEC 60900 : 2004

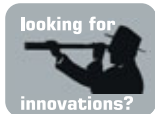

Item No

413 961 98



506

EAN-Code

40 07157 53169 8

Set 6-pcs VDE / Satz 6-tlg.

(4 x) 413: 3,0 x 100 / 4,0 x 100 / 5,5 x 125 / 6,5 x 150

(2 x) 414: PH 1 x 80 / PH 2 x 100



413



AC 1000V
IEC 60900 : 2004



Item No



EAN-Code

Set 6-pcs VDE / Satz 6-tlg.

413 963 98

413

40 07157 61081 2

[3 x] **413:** 2,5 x 75 / 4,0 x 100 / 5,5 x 125

[2 x] **414:** PH 1 x 80 / PH 2 x 100

[1 x] **361:** Mains testing screwdriver / Spannungsprüfer

VDE 0680/6, 220-250 Volt

419



M-TEC

AC 1000V
IEC 60900 : 2004



Item No



EAN-Code

toolcase 6 pcs M-Tec VDE / Koffer 6-tlg. M-Tec VDE

419 106 36

980

40 07157 61371 4

[6 x] **419:** 5,5 x 110 / 6,0 x 110 / 7,0 x 110 / 8,0 x 110

10,0 x 125 / 13,0 x 125

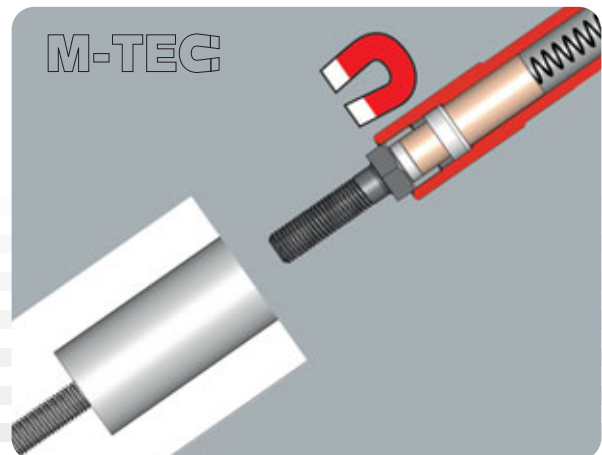
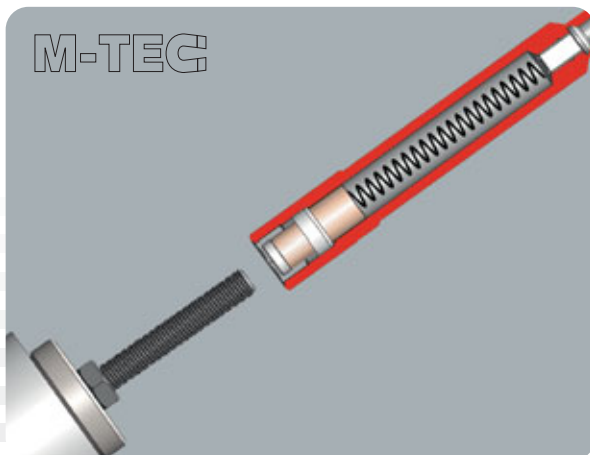

The Original *Das Original* VDE Serie 500

The leaders in • handle-design • blade quality
• 2-component-technology

Führend in • Design und Ergonomie
• Klingenqualität • 2Komponentengriff-Technik

513



AC 1000V
IEC 60900 : 2004

							Item No		EAN-Code
2,5 x 0,4	75	68	20	2,5	12		513 025 90	16	40 07157 22141 4
3,0 x 0,5	100	68	20	3,0	12		513 030 90	20	40 07157 22113 1
3,5 x 0,6	100	80	25	3,5	12		513 035 90	34	40 07157 22114 8
4,0 x 0,8	100	80	25	3,5	12		513 040 90	34	40 07157 22115 5
4,5 x 1,0	125	99	34	4,5	12		513 045 90	77	40 07157 50124 0
5,5 x 1,0	125	99	34	4,5	12		513 055 90	72	40 07157 22116 2
6,5 x 1,2	150	99	34	5,5	6		513 065 90	89	40 07157 22117 9
8,0 x 1,2	175	105	39	7,0	6		513 080 90	136	40 07157 22118 6

514



AC 1000V
IEC 60900 : 2004

PH						Item No		EAN-Code
0	60	80	25	3,0	12	514 001 90	28	40 07157 22142 1
1	80	90	29	4,5	12	514 102 90	49	40 07157 22119 3
2	100	99	34	6,0	12	514 203 90	83	40 07157 22120 9
3	150	105	39	8,0	6	514 304 90	145	40 07157 22143 8

515



AC 1000V
IEC 60900 : 2004

PZ						Item No		EAN-Code
1	80	90	29	4,5	12	515 102 90	49	40 07157 22121 6
2	100	99	34	6,0	12	515 203 90	83	40 07157 22122 3
3	150	105	39	8,0	6	515 304 90	147	40 07157 22144 5

518



AC 1000V
IEC 60900 : 2004



Bitholder				Item No		EAN-Code
1/4"	105	99	34	518 125 90	107	40 07157 50785 3

020



AC 1000V
IEC 60900 : 2004

E-Pro 11+1 pcs / 11+1 tlg		Item No		EAN-Code
(1 x) 518:	1/4" x 105	020 912 06	220	40 07157 51427 1
(4 x) 020:	3,0 x 0,5 / 4,0 x 0,8 / 5,5 x 1,0 / 7,0 x 1,2			
(2 x) 021:	PZ 1 / PZ 2			
(3 x) 022:	PH 0 / PH 1 / PH 2			
(2 x) 026:	Torx 20 / Torx 15			

513



AC 1000V
IEC 60900 : 2004

Set 6-pcs / Satz 6-tlg		Item No		EAN-Code
(4 x) 513:	3,0 x 100 / 3,5 x 100 / 4,0 x 100 / 5,5 x 125	513 961 97	490	40 07157 50176 9
(2 x) 514:	PH 1 x 80 / PH 2 x 100			

513



AC 1000V
IEC 60900 : 2004

	Item No		EAN-Code
Set 6-pcs / Satz 6-tlg	513 961 98	487	40 07157 50120 2
(3 x) 513:	3,5 x 100 / 4,0 x 100 / 5,5 x 125		
(2 x) 514:	PH 1 x 80 / PH 2 x 100		
(1 x) 361:	Mains testing screwdriver / Spannungsprüfer VDE 0680/6, 220-250 Volt		

513



AC 1000V
IEC 60900 : 2004

	Item No		EAN-Code
Set 5-pcs / Satz 5-tlg	513 951 98	360	40 07157 22136 0
(4 x) 513:	3,0 x 100 / 3,5 x 100 / 4,0 x 100 / 5,5 x 125		
(1 x) 515:	PZ 2 x 100		

513



AC 1000V
IEC 60900 : 2004

	Item No		EAN-Code
Set 3-pcs / Satz 3-tlg	513 931 14	236	40 07157 52235 1
(2 x) 513:	4,0 x 100 / 5,5 x 125		
(1 x) 514:	PH 2 x 100		

VDE Serie 600

High quality and comprehensive range

Überragend in Qualität,
Preis und Vielfalt

613



AC 1000V
IEC 60900 : 2004

						Item No		EAN-Code
2,5 x 0,4	75	75	23	2,5	12	613 025 90	20	40 07157 10134 1
3,0 x 0,5	100	75	23	3,0	12	613 030 90	24	40 07157 10137 2
3,5 x 0,6	100	80	25	3,5	12	613 035 90	30	40 07157 10139 6
4,0 x 0,8	100	90	29	3,5	12	613 040 90	40	40 07157 10141 9
5,5 x 1,0	125	99	34	4,5	12	613 055 90	64	40 07157 10143 3
6,5 x 1,2	150	99	34	5,5	6	613 065 90	81	40 07157 10146 4
8,0 x 1,2	175	105	39	7,0	6	613 080 90	126	40 07157 10147 1
8,0 x 1,6	200	105	39	7,0	6	613 090 90	136	40 07157 10148 8
10,0 x 1,6	200	115	42	8,0	6	613 100 90	182	40 07157 10149 5

614



AC 1000V
IEC 60900 : 2004

PH						Item No		EAN-Code
0	60	80	25	3,0	12	614 001 90	21	40 07157 24001 9
1	80	90	29	5,0	12	614 102 90	44	40 07157 10150 1
2	100	99	34	6,0	12	614 203 90	75	40 07157 10153 2
3	150	105	39	8,0	6	614 304 90	135	40 07157 10156 3

615



AC 1000V
IEC 60900 : 2004

PZ						Item No		EAN-Code
0	60	80	25	3,0	12	615 001 90	21	40 07157 24008 8
1	80	90	29	5,0	12	615 102 90	44	40 07157 24009 5
2	100	99	34	6,0	12	615 203 90	75	40 07157 24010 1
3	150	105	39	8,0	6	615 304 90	138	40 07157 24011 8

613
AC 1000V
IEC 60900 : 2004

	Item No		EAN-Code
Set 7-pcs / Satz 7-tlg	613 973 97	504	40 07157 51401 1
(5 x) 613:	2,5 x 75 / 3,0 x 100 / 3,5 x 100 / 4,0 x 100 / 5,5 x 125		
(2 x) 614:	PH 1 x 80 / PH 2 x 100		

613
AC 1000V
IEC 60900 : 2004

	Item No		EAN-Code
Set 7-pcs / Satz 7-tlg	613 974 97	558	40 07157 51403 5
(3 x) 613:	2,5 x 75 / 4,0 x 100 / 5,5 x 125		
(2 x) 614:	PH 1 x 80 / PH 2 x 100		
(2 x) 615:	PZ 1 x 80 / PZ 2 x 100		

613
AC 1000V
IEC 60900 : 2004

	Item No		EAN-Code
Set 6-pcs / Satz 6-tlg	613 962 98	362	40 07157 51405 9
(3 x) 613:	2,5 x 75 / 4,0 x 100 / 5,5 x 125		
(2 x) 614:	PH 1 x 80 / PH 2 x 100		
(1 x) 361:	Mains testing screwdriver / Spannungsprüfer VDE 0680/6, 220-250 Volt		

613

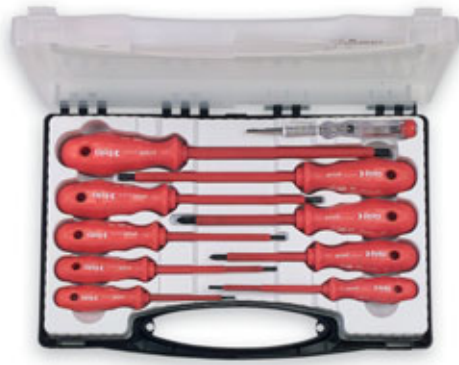

AC 1000V
IEC 60900 : 2004

	Item No		EAN-Code
Set 10-pcs / IEC Koffer 10-tlg.	600 110 96	912	40 07157 10021 4
(7 x) 613: 2,5 x 75 / 3,0 x 100 / 3,5 x 100 / 4,0 x 100 5,5 x 125 / 6,5 x 150 / 8,0 x 175			
(2 x) 614: PH 1 x 80 / PH 2 x 100			
(1 x) 361: Mains testing screwdriver / Spannungsprüfer VDE 0680/6, 220-250 Volt			

VDE Mains testing screwdriver / Spannungsprüfer

361



Mains testing screwdriver / Profi-Spannungsprüfer VDE 0680 150 V - 250 V

						Item No		EAN-Code
3,0 x 0,8	70 mm	23 mm			12	361 400 00	30	40 07157 52701 1

361



Mains testing screwdriver / Profi-Spannungsprüfer VDE 0680 150 V - 250 V on card / auf Karte

						Item No		EAN-Code
3,0 x 0,8	70 mm	23 mm			12	361 400 01	43	40 07157 53229 9

361



Mains testing screwdriver / Spannungsprüfer VDE 0680 220 V - 250 V

					Item No		EAN-Code
3,0 x 0,8	65 mm	13 mm		12	361 300 00	17	40 07157 26509 8
dto. on card / auf Karte				12	361 300 01	27	40 07157 26510 4

361



Mains testing screwdriver / Spannungsprüfer VDE 0680 220 V - 250 V

					Item No		EAN-Code
3,5 x 1,0	100 mm	17 mm		12	361 350 00	30	40 07157 26512 8
dto. on card / auf Karte				12	361 350 01	43	40 07157 26513 5

361



Mains testing screwdriver / Profi-Spannungsprüfer VDE 0680 150 V - 250 V

					Item No		EAN-Code
3,0 x 0,8	150 mm	25 mm		12	361 600 00	30	40 07157 31069 9
dto. in pouch / in Tasche				12	361 600 04	41	40 07157 52743 1

361



Mains testing screwdriver / Profi-Spannungsprüfer VDE 0680 150 V - 250 V

					Item No		EAN-Code
3,5 x 1,0	190 mm	25 mm		12	361 700 00	37	40 07157 31070 5
dto. in pouch / in Tasche				12	361 700 04	50	40 07157 52745 5

361



Item No



EAN-Code

Autolichtprüfer 6 V bis 24 V

on card / auf Karte

105 mm x 12 mm	12	363 100 05	66	40 07157 57551 7
----------------	----	-------------------	----	------------------

easy adjustment of torque

einfaches Einstellen des Drehmoments



coloured ring indicating torque range

Farbring zur Identifikation des Drehmomentbereiches

0,6 – 1,5 Nm 1,5 – 3,0 Nm 3,0 – 5,4 Nm



Torque screwdrivers with precise adjustment

Serie Nm (pat.)

Präzise einstellbare Drehmoment-Schraubendreher

ergonomically refined design

ergonomisch ausgereiftes Design

blades manufactured from chrome-molybdenum-vanadium steel

Klingen aus spezieller Chrom-Molybdän-Vanadium-Legierung

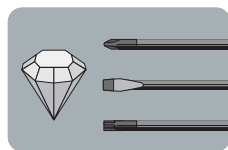

superior torque which exceeds DIN and ISO requirements by up to 100%

Beste Leistungsdaten, bis zu 100% über DIN-Werten

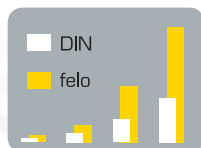

Precise release - indicated by acoustic and mechanic signals

Präzise Auslösung - deutlich spür- und hörbar - bei Erreichen des eingestellten Drehmomentes

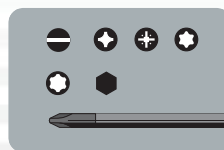

black tip for precision fit

Black-Tip für präzise Passung

exchangeable blades for greatest flexibility in all areas of use

Wechselklingen für höchste Flexibilität in allen Anwendungsbereichen



adjusted torque

eingestelltes Drehmoment 0,6 – 5,4 Nm

loosening torque

Lösemoment 100%

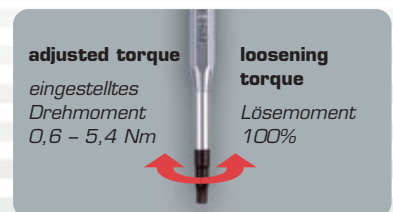



100

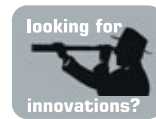

		Item No		EAN-Code
Nm-Box 0,6 Nm - 1,5 Nm 14-pcs / Satz 14-tlg		100 991 16	1190	40 07157 52039 5
[12 x]	Torx 6 / Torx 7 / Torx 8			
	IP 6 / IP 7 / IP 8 / IP 9			
	3,0 x 0,5 / 3,5 x 0,6			
	PH 0			
	PZ 0			
	Magnetic Bitholder / Magnethalter			
[1 x]	Handle / Griff 0,6 Nm - 1,5 Nm			
	Adjustment Tool / Einstellschlüssel			
	Metal Case / Metallbox: 220 mm / 110 mm / 35 mm			

100



		Item No		EAN-Code
Nm-Box 1,5 Nm - 3,0 Nm 14-pcs / Satz 14-tlg		100 992 16	1201	40 07157 52041 8
[12 x]	Torx 9 / Torx 10 / Torx 15			
	IP 9 / IP 10 / IP 15			
	4,0 x 0,8			
	PH 1 / PH 2			
	PZ 1 / PZ 2			
	Magnetic Bitholder / Magnethalter			
[1 x]	Handle / Griff 1,5 Nm - 3,0 Nm			
	Adjustment Tool / Einstellschlüssel			
	Metal Case / Metallbox: 220 mm / 110 mm / 35 mm			



100



	Item No		EAN-Code
Nm-Box 3,0 Nm - 5,4 Nm 14-pcs / Satz 14-tlg	100 993 16	1296	40 07157 52043 2
(12 x) Torx 15 / Torx 20 / Torx 25			
IP 9 / IP 10 / IP 15			
4,0 x 0,8			
PH 1 / PH 2			
PZ 1 / PZ 2			
Magnetic Bitholder / Magnethalter			
(1 x) Handle / Griff 3,0 Nm - 5,4 Nm			
Adjustment Tool / Einstellschlüssel			
Metal Case / Metallbox: 220 mm / 110 mm / 35 mm			



100

Handle / Griff	Nm max					Item No		EAN-Code
0,6 - 1,5 Nm	105	32			1	100 001 06	183	40 07157 52149 1
1,5 - 3,0 Nm	105	32			1	100 002 06	183	40 07157 52151 4
3,0 - 5,4 Nm	105	32			1	100 003 06	192	40 07157 52153 8

100

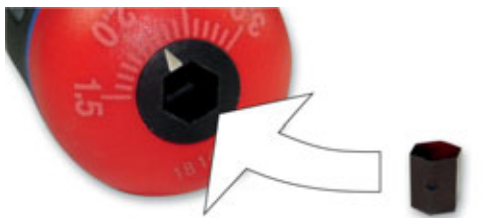

Torque-Seal /				Item No		EAN-Code
Verschuß-Siegel	8 mm	6 mm	1	100 006 00	2	40 07157 53413 2

100

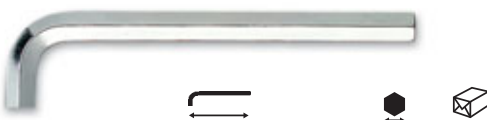

Einstellschlüssel 6mm / Einstellschlüssel			Item No		EAN-Code
85 mm	6 mm	1	100 060 00	27	40 07157 52155 2

108

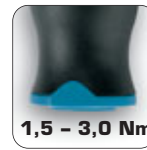

		Nm max			Item No		EAN-Code
Torx 6	170		1/4"	1	108 061 04	43	40 07157 51991 7
Torx 7	170		1/4"	1	108 071 04	43	40 07157 51993 1
Torx 8	170		1/4"	1	108 083 04	43	40 07157 51995 5
Torx 9	170		1/4"	1	108 093 04	43	40 07157 51997 9
Torx 10	170		1/4"	1	108 103 04	43	40 07157 51999 3
Torx 15	170		1/4"	1	108 153 04	44	40 07157 52001 2
Torx 20	170		1/4"	1	108 203 04	45	40 07157 52003 6
Torx 25	170		1/4"	1	108 253 04	46	40 07157 52005 0
IP 6	170		1/4"	1	109 061 04	43	40 07157 52007 4
IP 7	170		1/4"	1	109 071 04	43	40 07157 52009 8
IP 8	170		1/4"	1	109 083 04	43	40 07157 52011 1
IP 9	170		1/4"	1	109 093 04	43	40 07157 52013 5
IP 10	170		1/4"	1	109 103 04	43	40 07157 52015 9
IP 15	170		1/4"	1	109 153 04	44	40 07157 52017 3
3,0 x 0,5	170		1/4"	1	100 032 04	43	40 07157 52019 7
3,5 x 0,6	170		1/4"	1	100 353 04	44	40 07157 52021 0
4,0 x 0,8	170		1/4"	1	100 043 04	44	40 07157 52023 4
5,5 x 1,0	170		1/4"	1	100 554 04	45	40 07157 61245 8
PH 0	170		1/4"	1	102 001 04	43	40 07157 52025 8
PH 1	170		1/4"	1	102 102 04	45	40 07157 52027 2
PH 2	170		1/4"	1	102 203 04	46	40 07157 52029 6
PZ 0	170		1/4"	1	101 001 04	43	40 07157 52031 9
PZ 1	170		1/4"	1	101 102 04	45	40 07157 52033 3
PZ 2	170		1/4"	1	101 203 04	47	40 07157 52035 7
H 1 (+/-)	170		1/4"	1	106 102 04	45	40 07157 61247 2
H 2 (+/-)	170		1/4"	1	106 203 04	47	40 07157 61249 6
Z 1 (+/-)	170		1/4"	1	107 102 04	45	40 07157 57807 5
Z 2 (+/-)	170		1/4"	1	107 203 04	47	40 07157 57809 9
1,5mm	170		1/4"	1	104 015 04	43	41 07157 61625 8
2mm	170		1/4"	1	104 020 04	43	42 07157 61627 2
2,5mm	170		1/4"	1	104 025 04	43	43 07157 61629 6
3mm	170		1/4"	1	104 030 04	44	44 07157 61631 9
4mm	170		1/4"	1	105 040 04	44	45 07157 61633 3
Bitholder	170		1/4"	1	118 125 04	65	40 07157 52037 1

108



AC 1000V
IEC 60900 : 2004



	Nm VDE	Nm max			Item No		EAN-Code
3,5 x 0,6	170		1/4"	1	100 353 14	23	40 07157 61651 7
4,0 x 0,8	170		1/4"	1	100 043 14	24	40 07157 61653 1
5,5 x 1,0	170		1/4"	1	100 554 14	26	40 07157 61655 5
PH1	170		1/4"	1	102 102 14	26	40 07157 61657 9
PH2	170		1/4"	1	102 203 14	31	40 07157 61659 3
PZ1	170		1/4"	1	101 102 14	26	40 07157 61661 6
PZ2	170		1/4"	1	101 203 14	31	40 07157 61663 0
H2 +/-	170		1/4"	1	106 203 14	31	40 07157 61665 4
Z2 +/-	170		1/4"	1	107 203 14	31	40 07157 61667 8

freely rotating cap for minimal friction

leicht drehbare, ergonomisch ausgereifte Kappe

hanging hole for easy storage or inserting lever

*Querloch:
Zum Aufhängen der Werkzeuge oder zum Einstecken eines Hebels*



EAN code on every product

EAN-Code auf jedem Werkzeug

felo Precision Screwdrivers are setting the standards in all functional aspects.

Serie 240/250

Felo Präzisions-Schraubendreher setzen Maßstäbe in:

- Funktion • Qualität • Vielfalt
- 2Komponenten-Grifftechnik

pleasant soft grip material for added comfort

angenehm griffiger Weichmantel für ermüdungsfreies Arbeiten

anti-roll handle design

Griffkopf mit Abrollschutz

blades manufactured from chrome-molybdenum-vanadium steel

Klingen aus spezieller Chrom-Molybdän-Vanadium-Legierung

superior torque which exceeds DIN and ISO requirements by up to 100%

beste Leistungsdaten, bis zu 100% über DIN-Werten

ergonomically refined design

ergonomisch ausgereiftes Design

full-length polypropylene core

durchgehender, schlagfester Hartkern



felo Precision Screwdrivers are also available with ceramic blades or manufactured to ESD standards.

felo Präzisions-Schraubendreher auch in ESD-Ausführung oder als Abgleichwerkzeug

ESD Safe
10⁸ - 10¹⁰ Ω

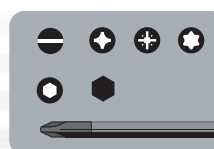

black tip for precision fit

Black-Tip für präzise Passung

240



									Item No		EAN-Code
1,5 x 0,23	60	90	14	2,5	12				240 151 50	20	40 07157 31738 4
2,0 x 0,4	60	90	14	2,5	12				240 201 50	20	40 07157 31740 7
2,5 x 0,4	60	90	14	2,5	12				240 252 50	20	40 07157 31742 1
2,5 x 0,4	150	90	14	2,5	12				240 255 50	24	40 07157 31744 5
2,5 x 0,4	200	90	14	2,5	12				240 257 50	25	40 07157 31746 9
3,0 x 0,5	60	90	14	3,0	12				240 033 50	22	40 07157 31748 3
3,0 x 0,5	100	103	19	3,0	12				240 035 50	24	40 07157 31750 6
3,0 x 0,5	200	103	19	3,0	12				240 037 50	29	40 07157 31752 0
3,5 x 0,6	60	103	19	3,0	12				240 333 50	24	40 07157 61307 3
3,5 x 0,6	100	103	19	3,5	12				240 353 50	26	40 07157 31754 4
3,5 x 0,6	150	103	19	3,5	12				240 355 50	31	40 07157 31756 8
3,5 x 0,6	250	103	19	3,5	12				240 358 50	39	40 07157 31758 2
4,0 x 0,8	100	103	19	4,0	12				240 043 50	30	40 07157 31760 5
4,0 x 0,8	150	103	19	4,0	12				240 045 50	35	40 07157 31762 9
4,0 x 0,8	200	103	19	4,0	12				240 047 50	40	40 07157 31764 3

241



								Item No		EAN-Code	
PZ											
0	60	90	14	3,0	12				241 001 50	19	40 07157 31766 7
1	60	103	19	4,5	12				241 102 50	29	40 07157 31768 1

242



								Item No		EAN-Code	
PH											
000	60	90	14	2,5	12				242 000 50	20	40 07157 31770 4
00	60	90	14	2,5	12				242 009 50	20	40 07157 31772 8
0	60	90	14	3,0	12				242 001 50	21	40 07157 31774 2
1	60	103	19	4,5	12				242 102 50	29	40 07157 31776 6
1	150	103	19	4,5	12				242 105 50	41	40 07157 31778 0



246



mm						Item No		EAN-Code
1,5	60	90	14	1,5	12	246 151 50	17	40 07157 31782 7
2	60	90	14	2,0	12	246 201 50	19	40 07157 31784 1
2,5	75	90	14	2,5	12	246 252 50	21	40 07157 31786 5
3	75	103	19	3,0	12	246 302 50	23	40 07157 31788 9

248



Torx						Item No		EAN-Code
5	60	90	14	3,0	12	248 051 50	20	40 07157 31790 2
6	60	90	14	3,0	12	248 061 50	20	40 07157 31792 6
7	60	90	14	3,0	12	248 071 50	21	40 07157 31794 0
8	60	90	14	3,0	12	248 081 50	22	40 07157 31796 4
9	60	90	14	3,5	12	248 091 50	22	40 07157 31798 8
10	60	103	19	3,5	12	248 103 50	26	40 07157 31800 8
10	250	103	19	3,5	6	248 108 50	38	40 07157 50276 6
15	100	103	19	4,0	12	248 153 50	30	40 07157 31802 2
15	250	103	19	4,0	6	248 158 50	45	40 07157 50278 0
20	250	103	19	4,0	6	248 208 50	61	40 07157 50280 3

249



mm					Item No		EAN-Code
3	60	103	19	6	249 300 50	29	40 07157 50709 9
3,5	60	103	19	6	249 350 50	29	40 07157 50711 2
4	60	103	19	6	249 400 50	30	40 07157 50713 6
4,5	60	103	19	6	249 450 50	30	40 07157 50715 0
5	60	103	19	6	249 500 50	31	40 07157 50717 4
5,5	60	103	19	6	249 550 50	31	40 07157 50719 8

240



	Item No		EAN-Code
Box 6-pce / Box. 6-tlg.	240 961 56	195	40 07157 31844 2
(4 x) 240: 1,5 x 60 / 2,0 x 60 / 2,5 x 60 / 3,0 x 60			
(2 x) 242: Phillips 00 x 60 / Phillips 0 x 60			
Box 6-pce / Box. 6-tlg.	248 961 56	194	40 07157 31846 6
(4 x) 248: Torx 6 x 60 / Torx 7 x 60 / Torx 8 x 60 / Torx 9 x 60			
(2 x) 246: 1,5 mm x 60 mm / 2,0 mm x 60 mm			

249



	Item No		EAN-Code
Box 6-pce / Box. 6-tlg.	249 961 56	254	40 07157 50721 1
(6 x) 249: 3,0 mm x 60 mm / 3,5 mm x 60 mm / 4,0 mm x 60 mm / 4,5 mm x 60 mm / 5,0 mm x 60 mm / 5,5 mm x 60 mm			

245



	Item No		EAN-Code
Watchmaker Screwdriver Set, 6-pce	245 972 06	193	40 07157 16026 3
<i>Uhrmacher Schraubendreher Satz, 6-tlg.</i>			
(6 x) 245: 0,8 / 1,2 / 1,8 / 2,5 / 2,9 / 3,6			

280



		Item No		EAN-Code
T4-Box 7-pce / T-Box.7-tlg.		280 907 06	163	40 07157 50723 5
{6 x}	Blade, Klinge			
	1,5 - 3,0 / 2,0 - 3,5 / 2,5 - 4,0			
	PH 1 - PH 0 / PH 00 - PH 000			
	PZ 1 - PZ 0			
{1 x}	Handle, Griff 102 x 19 mm			







T4-Box 7-pce / T-Box.7-tlg.		280 907 16	171	40 07157 50725 9
{6 x}	Blade, Klinge			
	1,3 mm - 4,0 mm / 1,5 mm - 2,0 mm / 2,5 mm - 3,0 mm			
	Torx 6 - Torx 15 / Torx 7 - Torx 10 / Torx 8 - Torx 9			
{1 x}	Handle, Griff 102 x 19 mm			



T4-Box 7-pce / T-Box.7-tlg.		280 907 26	164	40 07157 50727 3
{6 x}	Blade, Klinge			
	2,0 - 3,5			
	PH1 - PH 0 / PH 00 - PH 000			
	Torx 6 - Torx 15 / Torx 7 - Torx 10 / Torx 8 - Torx 9			
{1 x}	Handle, Griff 102 x 19 mm			

280



				Item No		EAN-Code
1,5 x 0,25 - 3,0 x 0,5	110 mm	4 mm	1	280 153 14	16	40 07157 50729 7
2,0 x 0,4 - 3,5 x 0,6	110 mm	4 mm	1	280 235 14	16	40 07157 50731 0
2,5 x 0,4 - 4,0 x 0,8	110 mm	4 mm	1	280 245 14	16	40 07157 50733 4
PH 00 - PH 000	110 mm	4 mm	1	282 000 14	16	40 07157 50737 2
PH 1 - PH 0	110 mm	4 mm	1	282 001 14	16	40 07157 50735 8
PZ 1 - PZ 0	110 mm	4 mm	1	281 010 14	16	40 07157 50739 6
1,3 mm - 4 mm	110 mm	4 mm	1	284 134 14	16	40 07157 50741 9
1,5 mm - 2 mm	110 mm	4 mm	1	284 152 14	16	40 07157 50743 3
2,5 mm - 3 mm	110 mm	4 mm	1	284 253 14	16	40 07157 50745 7
Torx 6 - Torx 15	110 mm	4 mm	1	286 615 14	16	40 07157 50747 1
Torx 7 - Torx 10	110 mm	4 mm	1	286 710 14	16	40 07157 50749 5
Torx 8 - Torx 9	110 mm	4 mm	1	286 890 14	16	40 07157 50751 8

250



ESD Safe
10⁸ - 10¹⁰ Ω



Size	Length	Width	Tip	Shaft	Box
1,5 x 0,23	60	102	19	2,5	12
2,0 x 0,4	60	102	19	2,5	12
2,5 x 0,4	60	102	19	2,5	12
3,0 x 0,5	60	102	19	3,0	12
3,0 x 0,5	100	102	19	3,0	12

Item No



EAN-Code

250 151 80	20	40 07157 31806 0
250 201 80	21	40 07157 31808 4
250 252 80	21	40 07157 31810 7
250 033 80	23	40 07157 31812 1
250 035 80	24	40 07157 31814 5

252



ESD Safe
10⁸ - 10¹⁰ Ω



Size	Length	Width	Tip	Shaft	Box
PH 00	60	102	19	2,0	12
0	60	102	19	3,0	12
1	80	102	19	4,5	12

Item No



EAN-Code

252 009 80	20	40 07157 31816 9
252 001 80	22	40 07157 31818 3
252 102 80	32	40 07157 31820 6



ESD Safe
10⁸ - 10¹⁰ Ω



250



ESD-Box 6-pce / ESD-Box 6-tlg.

Item No



EAN-Code

(4 x) 250:	1,5 x 60 / 2,0 x 60 / 2,5 x 60 / 3,0 x 60
(2 x) 252:	Phillips 00 x 60 / Phillips 0 x 60

250 961 86

202 40 07157 31848 0



ESD Safe
10⁸ - 10¹⁰ Ω



250



ESD-Box 12-pce / ESD-Box 12-tlg.

Item No



EAN-Code

(8 x) 050:	PZ 0 - PZ 1 / PH 2 - 0,8 x 4,0 / PH 1 - 0,5 x 3,0 SW 1,5 - SW 2,0 / SW 2,5 - SW 3,0 SW 4,0 - Torx 8 / Torx 10 - Torx 15 / Torx 5 - 0,4 x 2,5
(3 x) Ceramic:	PH 0 / 0,4 x 3,0 / 0,4 x 2,6 Handle / Griff ESD - Safe

250 120 06

159 40 07157 32426 9



telescopic depot for 7 bits
Teleskopmagazin für 7 Bits



ergonomically refined handle design for highest comfort and heavy duty use
ergonomisch ausgereifte Griffgestaltung für höchsten Komfort bei härtestem Einsatz

smooth, seamless handle for maximum comfort

nahtfrei glatte Kappe für minimale Reibung

easy to reach bits safely stored inside the handle

einfach zu öffnendes, versenkbares Depot garantiert sichere Aufbewahrung der Bits

pleasant soft grip material for highest torque

angenehm griffiger Weichmantel für höchste Drehmomente



Allround versatility and advanced ergonomics
Serie 370 (pat.)

Das Optimum an Vielseitigkeit und Ergonomie



Serie 373

with bitholder for power tool
mit Bithalter für Akkuwerkzeug

bitholder with stainless steel sleeve and extremely strong magnet

Bithalter mit Edelstahl-Hülse und extrem starkem Magneten



Serie 374

Magazine handle with ratchet

Magazingriff mit Ratsche

professional reversible ratchet - max. torque >24 Nm

Profi-Umschalratsche - übertragbares Drehmoment > 24 Nm



Sales displays on page 161

Verkaufsdiskys auf Seite 161



373



Item No



EAN-Code

Magazine Handle with bitholder for power tool on card 6 **373 108 05** 160 40 07157 52227 6

Magazingriff mit Bithalter für Akkuwerkzeug auf Karte

[8 x] 0,6 x 4,5 / 1,0 x 5,5 / 1,2 x 6,5

PH 0 / PH 1 / PH 2 / PZ 1 / PZ 2

Magazine Handle with bitholder for power tool on card 6 **373 208 05** 161 40 07157 52229 0

Magazingriff mit Bithalter für Akkuwerkzeug auf Karte

[8 x] Bits C 6,3 x 25 mm

1,0 x 5,5

PH 1 / PH 2 / PZ 1 / PZ 2

Torx 15 / Torx 20 / Torx 25

374

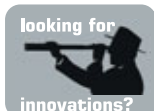

Item No



EAN-Code

[1 x] **Magazine Handle with Ratchet on card** 6 **374 004 05** 229 40 07157 52223 8

Magazingriff mit Ratsche auf Karte

[8 x] Bits C 6,3 x 25 mm

0,6 x 4,5 / 1,0 x 5,5 / 1,2 x 6,5

PH 0 / PH 1 / PH 2 / PZ 1 / PZ 2

[1 x] **Magazine Handle with Ratchet on card** 6 **374 204 05** 229 40 07157 52225 2

Magazingriff mit Ratsche auf Karte

[8 x] Bits C 6,3 x 25 mm

1,0 x 5,5

PH 1 / PH 2 / PZ 1 / PZ 2

Torx 15 / Torx 20 / Torx 25

376



Item No



EAN-Code

[1 x] **Magazine Handle Bitholder (long) on card** 6 **376 041 05** 188 40 07157 52221 4

Magazingriff Bithalter (lang) auf Karte

[8 x] Bits C 6,3 x 25 mm

0,6 x 4,5 / 1,0 x 5,5 / 1,2 x 6,5

PH 0 / PH 1 / PH 2 / PZ 1 / PZ 2

[1 x] **Magazine Handle Bitholder (long) on card** 6 **376 044 05** 188 40 07157 52569 7

Magazingriff Bithalter (lang) auf Karte

[8 x] Bits C 6,3 x 25 mm

1,0 x 5,5

PH 1 / PH 2 / PZ 1 / PZ 2

Torx 15 / Torx 20 / Torx 25

ergonomically refined soft grip coating

*angenehm griffiger Weichmantel:
Keine Druckstellen = mehr Kraft*

2-component handle for added comfort

2Komponenten Griff – Ihre Hand sollte es Ihnen wert sein



Made by professionals for professionals

T-Handle / T-Griffe

*Von Profis für Profis:
Qualität, Vielfalt, Funktionalität*

strong, durable core for the highest torque

*Hartkern für dauerhafte
Klingen-Griff-Verbindung auch
bei höchsten Belastungen*

hanging hole for easy storage

*Querloch:
Zum Aufhängen der Werkzeuge.*



Without soft-grip coating: extreme pressure points

*Ohne Weichmantel:
erhebliche Druckstellen*

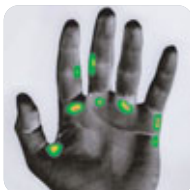

With soft grip coating: reduced pressure points

*Mit Weichmantel:
kaum Druckstellen*

EAN code on every product

*EAN-Code auf jedem
Werkzeug*



GS tested for safety

GS - geprüfte Sicherheit



blades made from chrome-vanadium steel and chrome-molybdenum-vanadium steel

*Klingen aus spezieller
Chrom-Vanadium und
Chrom-Molybdän-Vanadium-Legierung*

matt chrome-plated blades with black tips for precision fit

*matt verchromte Klingen
mit Black-Tip*



superior hardness which exceeds DIN and ISO requirements by up to 100%

*Beste Leistungsdaten,
bis zu 100% über
DIN-Werten*



303



mm					Item No		EAN-Code
2	100	100	2,0	12	303 203 80	58	40 07157 32248 7
2,5	100	100	2,5	12	303 253 80	60	40 07157 32250 0
3	150	100	3,0	8	303 035 80	66	40 07157 32252 4
4	150	100	4,0	8	303 045 80	74	40 07157 32254 8
5	150	100	5,0	8	303 055 80	84	40 07157 32256 2
6	150	100	6,0	8	303 065 80	100	40 07157 32258 6
8	150	100	8,0	8	303 085 80	134	40 07157 32260 9
8	200	100	8,0	8	303 087 80	155	40 07157 32262 3
10	200	100	10,0	8	303 107 80	198	40 07157 32264 7

304



mm				Item No		EAN-Code
5,5	230	100	8	304 558 80	113	40 07157 32266 1
6	125	100	8	304 064 80	94	40 07157 32296 8
6	230	100	8	304 068 80	167	40 07157 32268 5
7	230	100	8	304 078 80	138	40 07157 32270 8
8	125	100	8	304 084 80	109	40 07157 32300 2
8	230	100	8	304 088 80	141	40 07157 32272 2
8	350	100	8	304 089 80	177	40 07157 32274 6
9	230	100	8	304 098 80	142	40 07157 32276 0
10	125	100	8	304 104 80	124	40 07157 32304 0
10	230	100	8	304 108 80	166	40 07157 32278 4
10	350	100	8	304 109 80	213	40 07157 32280 7
11	230	100	8	304 118 80	174	40 07157 32282 1
12	230	100	8	304 128 80	175	40 07157 32284 5
13	125	100	8	304 134 80	138	40 07157 32310 1
13	230	100	8	304 138 80	177	40 07157 32286 9
13	350	100	8	304 139 80	225	40 07157 32288 3
17	230	100	8	304 178 80	202	40 07157 32292 0

308



Torx					Item No		EAN-Code
10	125	100	3,5	8	308 103 80	64	40 07157 50813 3
15	125	100	4,0	8	308 153 80	68	40 07157 50815 7
20	125	100	5,0	8	308 204 80	78	40 07157 32316 3
20	200	100	5,0	8	308 207 80	88	40 07157 32318 7
25	125	100	5,0	8	308 254 80	78	40 07157 32320 0
25	200	100	5,0	8	308 257 80	89	40 07157 32322 4
27	200	100	5,0	8	308 277 80	88	40 07157 32324 8
30	200	100	6,0	8	308 307 80	106	40 07157 32326 2
40	200	100	8,0	8	308 407 80	142	40 07157 32328 6
45	140	100	8,0	8	308 455 80	124	40 07157 32330 9

338



1/4"				Item No		EAN-Code
1/4"	125	100	6	338 125 80	111	40 07157 32350 7

303



Set 5-pcs / Satz 5-tlg.	Item No		EAN-Code
303: 3,0 / 4,0 / 5,0 / 6,0 / 8,0	303 951 80	1344	40 07157 50298 8
Steel Rack / Stahlblechständer			

313



mm					Item No		EAN-Code
2	120	60	4,0	5	313 020 00	23	40 07157 60319 7
2,5	120	60	4,0	5	313 025 00	23	40 07157 60323 4
3	140	70	4,0	5	313 030 00	26	40 07157 60325 8
3,5	140	70	6,0	5	313 035 00	26	40 07157 60327 2
4	170	85	6,0	5	313 040 00	66	40 07157 60329 6
4,5	170	85	6,0	5	313 045 00	66	40 07157 60331 9
5	170	85	6,0	5	313 050 00	66	40 07157 60333 3
6	200	100	8,0	5	313 060 00	140	40 07157 60335 7
7	200	100	8,0	5	313 070 00	140	40 07157 60337 1
8	240	120	10,0	5	313 080 00	260	40 07157 60339 5
9	260	135	10,0	5	313 090 00	280	40 07157 60341 8
10	280	145	12,0	5	313 100 00	435	40 07157 60343 2
12	300	155	14,0	5	313 120 00	625	40 07157 60345 6
14	320	165	16,0	5	313 140 00	890	40 07157 60347 0

340



						Item No		EAN-Code
4,0 x 0,8	125 mm			4,0 mm	12	340 040 00	13	40 07157 31018 7
	<i>dto. in pouch / in Tasche</i>					340 040 04	21	40 07157 57555 5
5,5 x 1,0	135 mm			5,5 mm	12	340 055 00	28	40 07157 31019 4
	<i>dto. in pouch / in Tasche</i>					340 055 04	36	40 07157 57559 3
8,0 x 1,2	200 mm			8,0 mm	12	340 080 00	89	40 07157 26004 8
	<i>dto. in pouch / in Tasche</i>					340 080 04	101	40 07157 57793 1
PZ								
1 + 2	135 mm			6,0 mm	12	341 120 00	35	40 07157 26006 2
	<i>dto. in pouch / in Tasche</i>					341 120 04	43	40 07157 57561 6
3 + 4	200 mm			8,0 mm	12	341 340 00	74	40 07157 26008 6
	<i>dto. in pouch / in Tasche</i>					341 340 04	82	40 07157 57565 4
PH								
1 + 2	135 mm			6,0 mm	12	342 120 00	35	40 07157 26010 9
	<i>dto. in pouch / in Tasche</i>					342 120 04	43	40 07157 57563 0
3 + 4	200 mm			8,0 mm	12	342 340 00	94	40 07157 26012 3
	<i>dto. in pouch / in Tasche</i>					342 340 04	106	40 07157 57795 5
PH								
6,0 + PH 2	135 mm			6,0 mm	12	343 260 00	35	40 07157 26014 7
	<i>dto. in pouch / in Tasche</i>					343 260 04	44	40 07157 57557 9

optimal hexagon shape, precision formed

optimal in engen Toleranzen gezogene Sechskant-Profile

virtually indestructible handle

Fast unzerstörbarer, patentierter Griff

made of special American high-torque alloy (Protanium™)

hergestellt aus amerikanischen Speziallegierungen (Protanium™)

30% increased anti-rust protection due to unique coating

durch spezielle Beschichtung bis zu 30% höherer Rostschutz

Sechskant-Schlüssel Hexagon Key Products

Höchste Qualität ohne Kompromiss

Hexagon keys with uncompromisingly high quality

improved ergonomic design to prevent injury

verbesserte Ergonomie verhindert Druckstellen



Blade movement radius of over 270°= timesaver by eliminating the need to exit and reenter the screw

Klingen über 270° klappbar=Zeitersparnis, da kein Umstecken notwendig

precisely machined ballpoint, even on the smallest size

Kugelköpfe präzise gefräst, auch bei kleinen Abmessungen



precision-engineered critical contact areas

Spezielle Geometrie in der kritischen Zone

careful tempering guarantees optimum hardness and elasticity

sorgfältige Vergütung garantiert optimale Härte und Elastizität

Torque exceeding that of leading competitors by up to 20%

Drehmoment bis zu 20% über den führenden Wettbewerbern

matte chrome surface

matt verchromte Oberfläche

15 year guarantee

15 Jahre Garantie

extra long arm for maximum leverage

extra lange Ausführung für extra Hebelwirkung

Black-tip for accurate fit

Black-Tip für höchste Passgenauigkeit

348



Torx					Item No		EAN-Code
5	33	19	2,5	3	348 105 50	3	40 07157 53317 3
6	33	19	2,5	3	348 106 50	3	40 07157 53319 7
7	33	19	2,5	3	348 107 50	4	40 07157 53321 0
8	33	19	2,5	3	348 108 50	4	40 07157 53323 4
9	37	24	3,0	3	348 109 50	5	40 07157 53325 8
10	37	24	3,0	3	348 110 50	6	40 07157 53327 2
15	43	28	4,0	3	348 115 50	8	40 07157 53329 6
20	43	28	4,0	3	348 120 50	11	40 07157 53331 9

349



Torx Plus					Item No		EAN-Code
IP 5	33	19	2,5	3	349 105 50	3	40 07157 53333 3
IP 6	33	19	2,5	3	349 106 50	3	40 07157 53335 7
IP 7	33	19	2,5	3	349 107 50	4	40 07157 53337 1
IP 8	33	19	2,5	3	349 108 50	4	40 07157 53339 5
IP 9	37	24	3,0	3	349 109 50	5	40 07157 53341 8
IP 10	37	24	3,0	3	349 110 50	6	40 07157 53343 2
IP 15	43	28	4,0	3	349 115 50	8	40 07157 53345 6
IP 20	43	28	4,0	3	349 120 50	11	40 07157 53347 0

348



Torx					Item No		EAN-Code
set 7 pcs / Satz 7-tlg					348 907 50	71	40 07157 60393 7
(7 x) 348: Torx 6 / Torx 7 / Torx 8 / Torx 9							
Torx 10 / Torx 15 / Torx 20							



349



Torx Plus

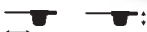

Item No



EAN-Code

set 7 pcs / Satz 7-tlg

349 907 50

71

40 07157 60395 1

(7 x) 349: IP 6 / IP 7 / IP 8 / IP 9
IP 10 / IP 15 / IP 20

348



Torx



Item No



EAN-Code

Torx				Item No		EAN-Code
6	42	2,5	12	348 006 00	2	40 07157 30742 2
7	48	2,5	12	348 007 00	2	40 07157 30743 9
8	48	2,5	12	348 008 00	2	40 07157 30744 6
9	48	3,0	12	348 009 00	2	40 07157 30745 3
10	86	3,5	12	348 010 00	7	40 07157 26054 3
15	91	3,5	12	348 015 00	8	40 07157 26055 0
20	95	4,0	12	348 020 00	11	40 07157 26056 7
25	100	5,0	12	348 025 00	17	40 07157 26057 4
27	105	6,0	12	348 027 00	27	40 07157 26058 1
30	115	6,0	12	348 030 00	30	40 07157 26059 8
40	124	8,0	12	348 040 00	56	40 07157 26060 4
45	133	8,0	12	348 045 00	61	40 07157 26061 1
50	152	9,0	12	348 050 00	88	40 07157 30746 0
55	172	12,0	12	348 055 00	161	40 07157 30747 7
60	190	13,5	12	348 060 00	248	40 07157 30748 4

348



Item No



EAN-Code

Set 8-pcs / Satz 8-tlg.

348 802 04

111

40 07157 50975 8

(8 x) 348: Torx 6 / Torx 7 / Torx 8 / Torx 9
Torx 10 / Torx 15 / Torx 20 / Torx 25



Set 8-pcs / Satz 8-tlg.

348 801 04

212

40 07157 31660 8

(8 x) 348: Torx 9 / Torx10 / Torx15 / Torx 20
Torx 25 / Torx 27 / Torx 30 / Torx 40

348



QUALITY
Made in USA

TF 8 Fold-Up / Handklapphalter

6

Item No

348 088 01



156

EAN-Code

40 07157 60401 9

Torx 9 / Torx 10 / Torx 15 / Torx 20 / Torx 25

Torx 27 / Torx 30 / Torx 40

348



QUALITY
Made in USA

LTX 8 Torx-Ballpoint Set, 8-pcs.

6

Item No

348 080 01



150

EAN-Code

40 07157 60403 3

Torx-Kugelkopf Satz 8 tlg.

Torx 09 / Torx 10 / Torx 15 / Torx 20 / Torx 25 / Torx 27 / Torx 30 / Torx 40

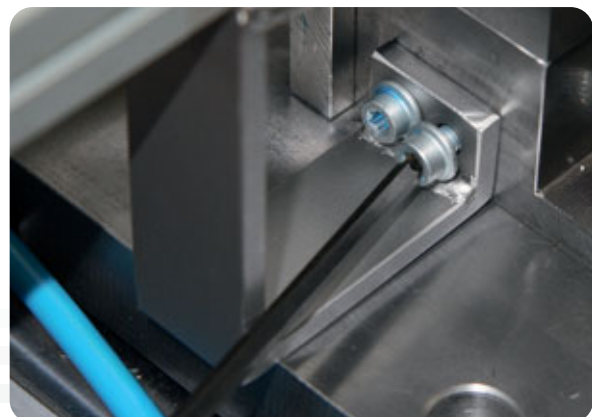

345



 **QUALITY**
Made in USA

				Item No		EAN-Code
1,5 mm	46,5	1,5	100	345 015 00	1	40 07157 26017 8
2,0 mm	52	2,0	100	345 020 00	2	40 07157 26018 5
2,5 mm	58,5	2,5	100	345 025 00	3	40 07157 26019 2
3,0 mm	66	3,0	100	345 030 00	5	40 07157 26020 8
4,0 mm	74	4,0	100	345 040 00	10	40 07157 26021 5
5,0 mm	85	5,0	100	345 050 00	18	40 07157 26022 2
6,0 mm	96	6,0	50	345 060 00	29	40 07157 26023 9
8,0 mm	108	8,0	50	345 080 00	58	40 07157 26024 6
10,0 mm	122	10,0	25	345 100 00	102	40 07157 26025 3
12,0 mm	137	12,0	10	345 120 00	162	40 07157 26026 0
14,0 mm	154	14,0	10	345 140 00	256	40 07157 26027 7
17,0 mm	177	17,0	5	345 170 00	431	40 07157 26028 4

355



 **QUALITY**
Made in USA

				Item No		EAN-Code
1,5 mm	80	1,5	10	355 015 00	1	40 07157 31022 4
2,0 mm	85	2,0	10	355 020 00	3	40 07157 31023 1
2,5 mm	90	2,5	10	355 025 00	4	40 07157 19082 6
3,0 mm	100	3,0	10	355 030 00	7	40 07157 19083 3
4,0 mm	112	4,0	10	355 040 00	14	40 07157 19084 0
5,0 mm	121	5,0	10	355 050 00	25	40 07157 19085 7
6,0 mm	140	6,0	10	355 060 00	41	40 07157 19086 4
8,0 mm	163	8,0	10	355 080 00	85	40 07157 19087 1
10,0 mm	190	10,0	5	355 100 00	152	40 07157 19088 8

365



QUALITY
Made in USA

				Item No		EAN-Code
1,5 mm	92	1,5	10	365 015 00	2	40 07157 50314 5
2,0 mm	102	2,0	10	365 020 00	3	40 07157 50316 9
2,5 mm	114	2,5	10	365 025 00	5	40 07157 50318 3
3,0 mm	128	3,0	10	365 030 00	9	40 07157 50320 6
4,0 mm	144	4,0	10	365 040 00	18	40 07157 50322 0
5,0 mm	162	5,0	10	365 050 00	32	40 07157 50324 4
6,0 mm	173	6,0	10	365 060 00	49	40 07157 50326 8
8,0 mm	197	8,0	10	365 080 00	99	40 07157 50328 2
10,0 mm	226	10,0	5	365 100 00	178	40 07157 50330 5

365



QUALITY
Made in USA

				Item No		EAN-Code
BLX 9 extra long Set 9-pcs Series 355			6	365 009 01	454	40 07157 60397 5
<i>BLX 9 extra lang Satz 9 tlg. Serie 355</i>						
1,5 mm / 2,0 mm / 2,5 mm / 3,0 mm / 4,0 mm						
5,0 mm / 6,0 mm / 8,0 mm / 10,0 mm						



QUALITY
Made in USA

345



Item No



EAN-Code

HF 7M Fold-Up / Handklapphalter 6

345 007 01

179

40 07157 60399 9

2,0 mm / 2,5 mm / 3,0 mm / 4,0 mm

5,0 mm / 6,0 mm / 8,0 mm



QUALITY
Made in USA

345



Item No



EAN-Code

BLX 6 Set 6-pcs. Short version, nickel plated 12

345 006 01

64

40 07157 60405 7

BLX 6 Satz 6-tlg. kurze Version, vernickelt

1,5 mm / 2,0 mm / 2,5 mm / 3,0 mm / 4,0 mm / 5,0 mm

355



Item No



QUALITY
Made in USA

EAN-Code

BLX 9 Set 9-pcs. Series 355

6

355 009 01

363

40 07157 60407 1

BLX 9 Satz 9-tlg. Serie 355

1,5 mm / 2,0 mm / 2,5 mm / 3,0 mm / 4,0 mm

5,0 mm / 6,0 mm / 8,0 mm / 10,0 mm

355



Item No



QUALITY
Made in USA

EAN-Code

BLX 15 Set 15-pcs. Series 355

6

355 150 01

653

40 07157 60409 5

BLX 15 Satz 15-tlg. Serie 355

1,27 / 1,5 mm / 2,0 mm / 2,5 mm / 3,0 mm / 3,5 mm

4,0 mm / 4,5 mm / 5,0 mm / 5,5 mm / 6,0 mm / 7,0 mm

8,0 mm / 9,0 mm / 10,0 mm

375



Item No



QUALITY
Made in USA

EAN-Code

BLX 13 Set 13-pcs. Inch Sizes

6

375 130 01

399

40 07157 60411 8

BLX 13 Satz 13-tlg. Zoll-Abmessungen

.050 1/16 5/64 3/32 7/64 1/8

9/64 5/32 3/16 7/32 1/4 5/16 3/8



**Extremely strong ratcheting mechanism with super fine-toothing
(>65Nm, 72 teeth, 5° ratcheting angle)**

*extrem starke Umschaltmechanik mit Super-Feinverzahnung
(>65Nm, 72 Zähne, 5°Rückholwinkel)*



**Sockets safely locked
and easily released by push-button**

*Steckschlüssel-Sicherheitsverriegelung
(mit Druckknopfauslösung)*

**Handle inseparably
connected with ratchet**

*Griff unlösbar mit dem
Schmiedeteil verbunden*

**1/4" tool sets with ERGONIC ratchet:
perfect and reliable without compromises**

*1/4 Zoll Werkzeug-Sets mit ERGONIC Ratsche:
perfekt und zuverlässig ohne Kompromisse*

R-GO



EP 1963072

**Patented ERGONIC handle with
cushion effect:
the ultimate of comfort!**

*patentierter ERGONIC Griff
mit Kissen-Effekt:
Mehr Komfort geht nicht!*

**Practice oriented assortments
stored in robust StrongBox**

*Verschiedene anwendungsgerechte
Sortimente in der stabilen
und sicheren StrongBox*

**Long lasting premium quality
in every detail:
15 years guarantee on every
component**

*Hochwertig und langlebig:
15 Jahre Garantie auf jedes Stück*





057



	Item No			EAN-Code
R-GO XL	36-pcs / Satz 36-tlg	057 836 16	955	40 07157 61547 3
[1 x]	ERGONIC Ratchet 1/4" / <i>ERGONIC Ratsche 1/4"</i>			
[1 x]	ERGONIC Stubby 1/4" / <i>ERGONIC Stubby 1/4"</i>			
[13 x]	Sockets / Steckschlüsseleinsätze			
	4mm / 4,5mm / 5mm / 5,5mm / 6mm / 7mm / 8mm / 9mm / 10mm / 11mm / 12mm / 13mm / 14mm			
[15 x]	Bits (C6,3 x 25mm)			
	4,5 x 0,6 / 5,5 x 1,0			
	4mm / 5mm / 6mm			
	PH1 / PH2 / PH3			
	PZ1 / PZ2			
	Torx 10 / Torx 15 / Torx 20 / Torx 25 / Torx 30			
[1 x]	Extension / Verlängerung (100mm) 1/4" - 1/4"			
[1 x]	Extension / Verlängerung (50mm) 1/4" - 1/4"			
[1 x]	U-Joint / Kardangelenk 1/4"			
[1 x]	Bitholder / Bithalter E6,3 x 58mm			
[1 x]	Adapter / Adapter E 6,3 - 1/4" (50mm)			
[1 x]	Adapter / Adapter 1/4" SQ - 1/4" Hex			
	StrongBox 230 mm x 130 mm x 56 mm			

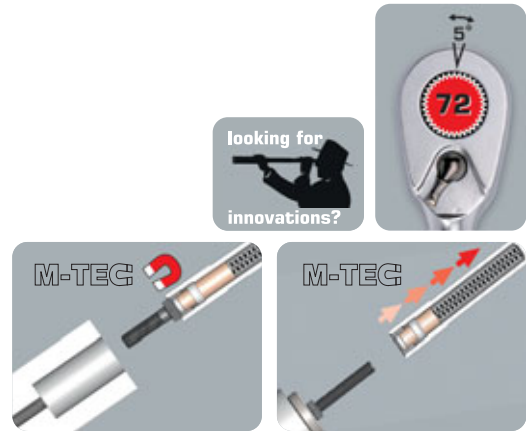

057

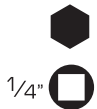

		Item No		EAN-Code
	R-GO M-Tec Box 10-pcs / Satz 10-tlg	057 810 06	1050g	40 07157 615534
[1 x]	ERGONIC Ratchet 1/4" / ERGONIC Ratsche 1/4"			
[1 x]	ERGONIC Screwdriver with 1/4" adapter for sockets / <i>ERGONIC Schraubendreher mit 1/4" Adapter für Steckschlüsseinsätze</i>			
[6 x]	Nutdrivers / M-Tec Steckschlüssel 5,5mm/ 6mm/ 7mm/ 8mm/ 10mm/ 13mm			
[1 x]	Extension / Verlängerung (100mm) 1/4" - 1/4"			
[1 x]	U-Joint / Kardangelenk 1/4"			
	StrongBox 230 mm x 130 mm x 56 mm			



057



		Item No		EAN-Code
	R-GO 19 Box 19-pcs / Satz 19-tlg	057 819 06	955g	40 07157 61555 8
[1 x]	ERGONIC Ratchet 1/4" / ERGONIC Ratsche 1/4"			
[1 x]	ERGONIC Screwdriver with 1/4" adapter for sockets / <i>ERGONIC Schraubendreher mit 1/4" Adapter für Steckschlüsseinsätze</i>			
[13 x]	Sockets / Steckschlüsseinsätze 4mm / 4,5mm / 5mm/ 5,5mm/ 6mm/ 7mm/ 8mm/ 9mm/ 10mm/ 11mm/ 12mm/ 13mm/ 14mm			
[1 x]	Extension / Verlängerung (100mm) 1/4" - 1/4"			
[1 x]	Extension / Verlängerung (50mm) 1/4" - 1/4"			
[1 x]	U-Joint / Kardangelenk 1/4"			
[1 x]	Adapter / Adapter E 6,3 - 1/4" (50mm)			
	StrongBox 230 mm x 130 mm x 56 mm			

057



	Item No	Weight	EAN-Code
R-GO 36 Box 36-pcs / Satz 36-tlg	057 836 06	900g	4007157 61557 2
(1 x) ERGONIC Ratchet 1/4" / ERGONIC Ratsche 1/4"			
(1 x) ERGONIC 438 Screwdriver with Bitholder / ERGONIC 438 Schraubendreher mit Bithalter			
(30 x) Bits (C6,3 x 25mm)			
3,0 x 0,5/ 4,5 x 0,6 / 5,5 x 1,0/ 6,5 x 1,2			
2mm/ 3mm/ 4mm/ 5mm/ 6mm			
PH0/ PH1/ PH2/ PH3			
PZ1/ PZ2 / PZ3			
Torx 5/ Torx 6/ Torx 7/ Torx 8/ Torx 10 / Torx 15 / Torx 20/ Torx 25/ Torx 30/ Torx 40			
SQ1 / SQ2			
Spanner6/ Spanner8			
(1 x) Extension (100mm) 1/4" - 1/4" / Verlängerung			
(1 x) Extension (50mm) 1/4" - 1/4" / Verlängerung			
(1 x) Bitholder E6,3 x 58mm / Bithalter			
(1 x) Adapter 1/4" SQ - 1/4" Hex / Adapter			
StrongBox 230 mm x 130 mm x 56 mm			



497

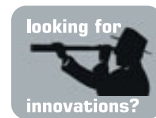

	Item No	Weight	EAN-Code
ERGONIC Ratchet 1/4" in Blister/	497 635 41	128	40 07157 61481 0
<i>ERGONIC Ratsche 1/4" auf Karte</i>			

096

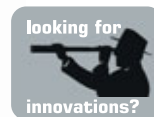

	Item No	Weight	EAN-Code
Nutdriver M-TEC / Steckschlüssel M-TEC			
5,5mm	096 055 20	31	40 07157 61713 2
6mm	096 060 20	33	40 07157 61715 6
7mm	096 070 20	41	40 07157 61717 0
8mm	096 080 20	45	40 07157 61719 4
10mm	096 100 20	57	40 07157 61721 7
13mm	096 130 20	114	40 07157 61723 1



**Super strong ratcheting mechanism with fine toothing
(>65 Nm, 60 teeth, 6° ratcheting angle)**

*Super-starke Umschaltmechanik mit Feinverzahnung
(>65Nm, 60 Zähne, 6° Rückholwinkel)*

**Direct fit for bits =
extreme low operating height**

*mit Bit-Direktaufnahme -
extrem niedrige Kopfhöhe!*



**Slightly angled handle makes work
more comfortable and protects
the fingers**

*Leicht abgewinkelter Griff erleichtert
das Arbeiten und schützt die Finger*

XS

Pocket size tool sets built for tough work in tight spaces

*Werkzeugsätze im Hosentaschen-Format:
gebaut für harten Einsatz auf beengtem Raum*



**Ratchet forged in one piece
from chrom-vanadium steel**

*Ratsche einteilig aus Chrom
Vanadium Stahl geschmiedet*

**Practice oriented assortments
stored in robust, splashproof
mini StrongBox**

*Verschiedene anwendungsgerechte
Sortimente in der stabilen, spritz-
wassergeschützten mini StrongBox*

**Long lasting premium quality
in every detail:
15 years guarantee on every
component**

*Hochwertig und langlebig:
15 Jahre Garantie auf jedes Stück*



057

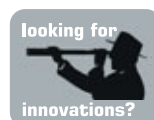

		Item No		EAN-Code
XS 11	11-pcs / Satz 11-tlg	057 711 06	410	40 07157 61559 6
[1 x]	Mini Ratchet 1/4" / Miniratsche 1/4"			
[7 x]	Sockets / Steckschlüsseleinsätze 5,5mm/ 6mm/ 7mm/ 8mm/ 10mm/ 11mm/ 13mm/			
[1 x]	Extension / Verlängerung (100mm) 1/4" - 1/4"			
[1 x]	Adapter / Adapter E 6,3 - 1/4" (50mm)			
[1 x]	Adapter / Adapter C 6,3 - 1/4" (25mm)			
	StrongBox 135mm x 75mm x 37mm			

057



		Item No		EAN-Code
XS 18	18-pcs / Satz 18-tlg	057 718 06	420	40 07157 61561 9
[1 x]	Mini Ratchet 1/4" / Miniratsche 1/4"			
[7 x]	Sockets / Steckschlüsseleinsätze 5mm/ 5,5mm/ 6mm/ 7mm/ 8mm/ 10mm/ 13mm			
[7 x]	Bits (C6,3 x 25mm) 4,5 x 0,6 / 5,5 x 1,0/ 6,5 x 1,2 PH1/ PH2/ PH3 PZ2			
[1 x]	Extension / Verlängerung (50mm) 1/4" - 1/4"			
[1 x]	Adapter / Adapter C 6,3 - 1/4" (25mm)			
[1 x]	Bitholder / Bithalter E6,3 x 58mm			
	StrongBox 135mm x 75mm x 37mm			



057



		Item No		EAN-Code
XS 33	33-pcs / Satz 33-tlg	057 733 06	425	40 07157 61545 9
[1 x]	Mini Ratchet 1/4" / Miniratsche 1/4"			
[30 x]	Bits (C6,3 x 25mm)			
	3,0 x 0,5 / 5,0 x 0,8 / 6,5 x 1,2			
	2mm/ 2,5mm/ 3mm/ 4mm/ 5mm/ 6mm/ 8mm			
	PH0/ PH1/ 2x PH2/ PH3			
	PZ1/ 2x PZ2 / PZ3			
	Torx 6/ Torx 7/ Torx 8/ Torx 9			
	Torx TR10 / Torx TR15/ Torx TR20/ Torx TR25/ Torx TR27/ Torx TR30/ Torx TR40			
[1 x]	Adapter / Adapter C 6,3 - 1/4" (25mm)			
[1 x]	Bitholder / Bithalter E6,3 x 58mm			
	StrongBox 135mm x 75mm x 37mm			



057



		Item No		EAN-Code
Mini Ratchet 1/4" with Adapter C 6,3 - 1/4" in blister		057 635 01	118	40 07157 61569 5
<i>Miniratsche 1/4" mit Adapter C 6,3 - 1/4" auf Karte</i>				



438



		Item No		EAN-Code
ERGONIC Stubby Handle 1/4"	61 25 1	438 025 40	32	40 07157 61585 5
<i>ERGONIC Stubby Griff 1/4"</i>				

389





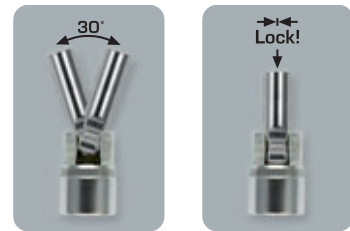

	Item No		EAN-Code
Belt-Pouch for XS StrongBox in blister	389 800 01	100	40 07157 61733 0

Gürteltasche für XS Strongbox in blister

097



1/4" ■	  			Item No		EAN-Code
	Extension / Verlängerung					
	50mm	1/4"	1	097 050 10	22	40 07157 61683 8
	100mm	1/4"	1	097 100 10	43	40 07157 61681 4

097







1/4" ■	Item No		EAN-Code
U-Joint 1/4"	1 097 000 10	22	40 07157 61729 3

Kardangelenk 1/4"

097



1/4" ■	   				Item No		EAN-Code
Adapter	25 mm	1/4"	C 6,3	1	097 019 10	25	40 07157 61685 2

096



mm				Item No		EAN-Code
4	25	1/4"	1	096 040 10	10	40 07157 61687 6
4,5	25	1/4"	1	096 045 10	10	40 07157 61689 0
5	25	1/4"	1	096 050 10	10	40 07157 61691 3
5,5	25	1/4"	1	096 055 10	10	40 07157 61693 7
6	25	1/4"	1	096 060 10	11	40 07157 61695 1
7	25	1/4"	1	096 070 10	11	40 07157 61697 5
8	25	1/4"	1	096 080 10	12	40 07157 61699 9
9	25	1/4"	1	096 090 10	12	40 07157 61701 9
10	25	1/4"	1	096 100 10	12	40 07157 61703 3
11	25	1/4"	1	096 110 10	18	40 07157 61705 7
12	25	1/4"	1	096 120 10	21	40 07157 61707 1
13	25	1/4"	1	096 130 10	23	40 07157 61709 5
14	25	1/4"	1	096 140 10	31	40 07157 61711 8

2-component handle with pleasant soft grip material for highest torque

2-Komponenten Griff mit angenehm griffigen Weichmantel für höchste Drehmomente

Professional quality & great versatility

Kompromißlose Profi-Qualität und größte Einsatz-Vielfalt

smart

screwdriver and T-handle in one

Schraubendreher und T-Griff in Einem



ergonomically refined design

ergonomisch ausgereiftes Design

replaces 48 single tools

ersetzt 48 Einzelwerkzeuge

blades made from high-quality bit-steels, exceeding the DIN/ISO requirements by up to 100%

Klingen aus Hochleistungs-Bitstählen, Härte/Drehmoment bis zu 100% über DIN-Werten

anti-roll handle design

Griffkopf mit Abrollschutz

GS tested for safety

GS - geprüfte Sicherheit



fitting the complete 1/4" range

passend für das komplette 1/4" Normprogramm

black tip for precision fit

Black-Tip für präzise Passung

060



		Item No		EAN-Code
Felo-SMART	Box 13-pcs / Satz 13-tlg.	060 813 06	1090	40 07157 60413 2
[12 x]	Blade / Klinge 1/4" x 160 mm			
	PH 1 – 4,0 / PH 2 – PH 3 / PZ 1 – 5,0 / PZ 2 – 6,0 / PZ 3 – 7,0			
	3 mm – 4 mm / 5 mm – 6 mm /			
	Torx 6 – Torx 7 / Torx 8 – Torx 9 / Torx 10 – Torx 15 / Torx 20 – Torx 25 / Torx 30 – Torx 40			
[1 x]	Handle / Griff 105 x 39 mm			
	StrongBox 230mm x 130mm x 56mm			

060

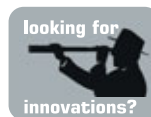

		Item No		EAN-Code
Felo-SMART II	Box 29-pcs / Satz 29-tlg	060 815 06	1058	40 07157 60415 6
[16 x]	Bits C 6,3 x 25 mm			
	PH 1 / PH 2 / PH 3 / PZ 1 / PZ 2 / PZ 3			
	5 mm / 6 mm / 3,5 x 0,6 / 5,0 x 0,8 / 6,5 x 1,2			
	Torx15 / Torx 20 / Torx 25 / Torx 30 / Torx 40			
[1 x]	Bit Holder with Quick-Release Chuck / Bit Schnellwechselfutter			
[7 x]	Socket / Steckschlüssel			
	4 mm / 5 mm / 5,5 mm / 6 mm / 8 mm / 10 mm / 13 mm			
[1 x]	Adapter / Adapter 1/4" – C 6,3 (Art.No. 097 018 10)			
[1 x]	Extension / Verlängerung , 1/4" – E 6,3 (Art.No. 097 150 14)			
[1 x]	Extension for Sockets / Verlängerung für Steckschlüssel 75 mm			
[1 x]	Profi Ratchet / Profi Ratsche 1/4"			
[1 x]	Handle / Griff 105 x 39 mm			
	StrongBox 230mm x 130mm x 56mm			



060



	Item No		EAN-Code
Felo-SMART II INCH Version / Zoll-Version	060 815 36	1058	40 07157 60417 0
Box 29-pcs / Satz 29-tlg			
(16 x) Bits C 6,3 x 25 mm			
PH 1 / PH 2 / PH 3 / PZ 1 / PZ 2 / PZ 3			
3/16" 1/4" 3,5 x 0,6 / 5,0 x 0,8 / 6,5 x 1,2			
Torx 15 / Torx 20 / Torx 25 / Torx 30 / Torx 40			
(1 x) Bit Holder with Quick-Release Chuck / Bit Schnellwechselfutter			
(7 x) Socket / Steckschlüssel			
3/16" 7/32" 1/4" 9/32" 5/16" 3/8" 1/2"			
(1 x) Adapter 1/4" - C 6,3 (Art.No. 097 018 10)			
(1 x) Extension / Verlängerung 1/4" - E 6,3 (Art.No. 097 150 14)			
(1 x) Extension for Sockets / Verlängerung für Steckschlüssel 75 mm			
(1 x) Profi Ratchet / Profi Ratsche 1/4"			
(1 x) Handle / Griff 105 x 39 mm			
StrongBox 230mm x 130mm x 56mm			



060





	Item No		EAN-Code
Felo-SMART Mechanik Box 12-pcs / Satz 12-tlg	060 912 06	1216	40 07157 50202 5
(7 x) Blade / Klinge 1/4" x 160 mm			
PH 1 - 4,0 / PH 2 - PH 3 / PZ 2 - 6,0			
3 mm - 4 mm / 5 mm - 6 mm / Torx 20 - Torx 25 / Torx 30 - Torx 40			
(4 x) Socket / Steckschlüssel E 6,3 x 155			
7 mm / 8 mm / 10 mm / 13 mm			
(1 x) Handle / Griff 105 x 39 mm			
Metal Case / Stahlblech Box 220 mm, 110 mm, 35 mm			

060



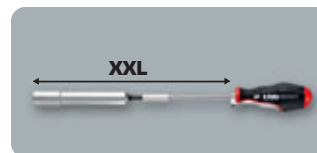
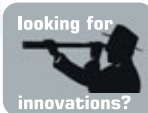

M-TEC

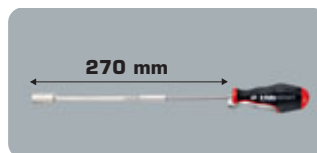
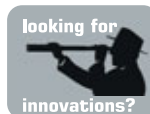

	Item No		EAN-Code
Felo-SMART Engineer Box 20-pcs / Satz 20-tlg [7 x] M-Tec 1/4"	060 820 06	1218	40 07157 60421 7
5,5 mm x 116 mm / 6 mm x 116 mm / 7 mm x 116 mm / 8 mm x 116 mm / 10 mm x 133 mm / 13 mm x 133 mm / 17 x 158 mm			
[1 x] Bitholder / Bithalter 1/4" x 58 mm			
[1 x] Bitholder / Bithalter 1/4" x 155 mm			
[10 x] Bits C 6,3 x 25 mm PH 1 / PH 2 / PZ 1 / PZ 2 3,5 x 0,6 / 5,0 x 0,8 Torx 15 / Torx 20 / Torx 25 / Torx 30			
[1 x] Handle / Griff 105 x 39 mm			
StrongBox 230mm x 130mm x 56mm			

060



	Item No		EAN-Code
Felo-SMART Engineer Inch Version / Zoll Version Box 20-pcs / Satz 20-tlg	060 920 36	1286	40 07157 52953 4
[8 x] Socket / Steckschlüssel E 6,3 x 155 7/32" 1/4" 9/32" 5/16" 3/8" 7/16" 1/2" 9/16"			
[1 x] Bitholder / Bithalter 1/4"			
[10 x] Bits C 6,3 x 25 mm PH1 / PH2 / PZ 1 / PZ 2 3,5 x 0,6 / 5,0 x 0,8 Torx 15 / Torx 20 / Torx 25 / Torx 30			
[1 x] Handle / Griff 105 x 39 mm			
Metal Case / Stahlblech Box 220 mm, 110 mm, 35 mm			

060



		Item No		EAN-Code
Felo-SMART belt pouch / Gürteltasche		060 809 04	566	40 07157 60425 5
Pouch 9-pcs / Gürteltasche 9-tlg				
(8 x)	Blade / Klinge			
	PH 1 - 4,0 / PH 2 - PH 3			
	PZ 1 - 5,0 / PZ 2 - 6,0 / PZ 3 - 7,0			
	5 mm - 6 mm /			
	Torx 20 - Torx 25 / Torx 30 - Torx 40			
(1 x)	Handle / Griff 105 x 39 mm			
	Nylon Pouch / Nylon Tasche			

069



		Item No		EAN-Code
SMART-Handle / SMART-Griff		069 205 00	105	40 07157 60427 9





069



		Item No		EAN-Code
Nylon Pouch / Nylon Tasche		389 900 00	80	40 07157 50456 2

068



				Item No		EAN-Code
7/32"	155 mm	E 6,3 / 1/4"	1	068 555 04	51	40 07157 53195 7
1/4"	155 mm	E 6,3 / 1/4"	1	068 635 04	52	40 07157 53197 1
9/32"	155 mm	E 6,3 / 1/4"	1	068 714 04	57	40 07157 53199 5
5/16"	155 mm	E 6,3 / 1/4"	1	068 793 04	59	40 07157 53201 5
3/8"	155 mm	E 6,3 / 1/4"	1	068 952 04	64	40 07157 53203 9
7/16"	155 mm	E 6,3 / 1/4"	1	068 111 04	72	40 07157 53205 3
1/2"	155 mm	E 6,3 / 1/4"	1	068 127 04	77	40 07157 53207 7
9/16"	155 mm	E 6,3 / 1/4"	1	068 142 04	77	40 07157 53209 1



				Item No		EAN-Code
PH 1 - 4,0 x 0,8	160 mm	1/4"	1	062 104 04	42	40 07157 32116 9
PH 1 - 7,0 x 1,2	160 mm	1/4"	1	062 107 04	43	40 07157 50312 1
PH 2 - PH 3	160 mm	1/4"	1	062 023 04	44	40 07157 32118 3
PH 2 - 6,0 x 1,0	160 mm	1/4"	1	062 206 04	41	40 07157 50310 7
PZ 1 - 5,0 x 0,8	160 mm	1/4"	1	061 105 04	42	40 07157 32110 7
PZ 2 - 6,0 x 1,0	160 mm	1/4"	1	061 206 04	43	40 07157 32112 1
PZ 3 - 7,0 x 1,2	160 mm	1/4"	1	061 307 04	44	40 07157 32114 5
3 mm - 4 mm	160 mm	1/4"	1	064 034 04	44	40 07157 32106 0
5 mm - 6 mm	160 mm	1/4"	1	064 056 04	45	40 07157 32130 5
Torx 06 - Torx 07	160 mm	1/4"	1	066 067 04	42	40 07157 32096 4
Torx 08 - Torx 09	160 mm	1/4"	1	066 089 04	41	40 07157 32098 8
Torx 10 - Torx 15	160 mm	1/4"	1	066 115 04	41	40 07157 32100 8
Torx 20 - Torx 25	160 mm	1/4"	1	066 225 04	42	40 07157 32102 2
Torx 30 - Torx 40	160 mm	1/4"	1	066 340 04	45	40 07157 32104 6
SQ 0 - SQ 1	160 mm	1/4"	1	065 001 04	46	40 07157 50346 6
SQ 2 - SQ 3	160 mm	1/4"	1	065 023 04	48	40 07157 50348 0
XZN M6 - XZN M5	160 mm	1/4"	1	068 065 04	49	40 07157 50344 2
TX10TR - TX15TR	160 mm	1/4"	1	067 115 04	46	40 07157 32120 6
TX20TR - TX25TR	160 mm	1/4"	1	067 225 04	46	40 07157 32122 0
TX30TR -TX40TR	160 mm	1/4"	1	067 340 04	48	40 07157 32124 4



068

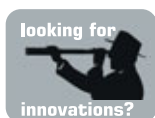

				Item No		EAN-Code
5,5 mm	116 mm	1/4"	1	068 055 24	50	40 07157 60541 2
6,0 mm	116 mm	1/4"	1	068 060 24	66	40 07157 60543 6
7,0 mm	116 mm	1/4"	1	068 070 24	69	40 07157 60545 0
8,0 mm	116 mm	1/4"	1	068 080 24	72	40 07157 60547 4
10,0 mm	133 mm	1/4"	1	068 100 24	87	40 07157 60549 8
13,0 mm	133 mm	1/4"	1	068 130 24	137	40 07157 60551 1
17,0 mm	158 mm	1/4"	1	068 170 24	217	40 07157 60553 5



097



				Item No		EAN-Code
Adapter	150 mm	E 6,3 / 1/4"	1	097 150 14	62	40 07157 32128 2
Bitholder / Bithalter	155 mm	1/4"	1	068 635 14	62	40 07157 53179 7

12 interchangeable IEC screwdriver blades with 2-component handle in sturdy smart box

12 IEC Wechselklingen mit 2-Komponenten-Griff in robuster smart Box

every screwdriver individually tested to 10.000 Volts, fully conforming to DIN EN 60900

Sicherheitswerkzeug nach DIN EN 60900 – alle Schraubendreher stückgeprüft mit 10.000 Volt

**AC 1000V
IEC 60900 : 2004**



secure fit of blades, quick-release button on handle against unwanted extraction

sicherer Halt der Klingen im Griff, automatische Verriegelung gegen ungewolltes Herausziehen



The first compact smart tool for electricians.
Esmart (pat.)

Das erste kompakte smart-Werkzeug für Elektriker.



precision cap and soft-grip zone on blades for low torque application

aufsteckbare Drehkappe und Weichmantelzone für Einsatz als Feinwerkzeuge



063



AC 1000V
IEC 60900 : 2004



Item No



EAN-Code

Felo E-SMART	Box 14-pce / Box 14-tlg.	063 913 06	984	40 07157 51719 7
[12 x]	Blade / Klinge			
	2,5 x 0,4 / 3,0 x 0,5 / 3,5 x 0,6 / 4,0 x 0,8 / 5,5 x 1,0 / 6,5 x 1,2			
	PH1 / PH2			
	PZ2			
	Torx 10 / Torx 15 / Torx 20			
[1 x]	Handle / Griff 95 x 32 mm			
[1 x]	Precision Cap / Drehkappe			
	StrongBox 230mm x 130mm x 56mm			

060

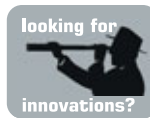

AC 1000V
IEC 60900 : 2004



Item No



EAN-Code

Felo E-SMART Industry Box	14-pce / Box 14-tlg.	063 913 16	1071	40 07157 53263 3
[10 x]	Blade / Klinge			
	2,5 x 0,4 / 3,0 x 0,5 / 3,5 x 0,6 / 4,0 x 0,8 / 5,5 x 1,0 / 6,5 x 1,2			
	PH 1 / PH 2			
	PZ 2			
	Z 2			
[1 x]	Bit, Spanner 10 x 25			
[1 x]	Universal Cabinet key / Schaltschrankschlüssel			
[1 x]	Handle / Griff 95 x 32 mm			
[1 x]	Precision Cap / Drehkappe			
	StrongBox 230mm x 130mm x 56mm			

063



AC 1000V
IEC 60900 : 2004



Item No



EAN-Code

Felo E-SMART Box in Blister Box 14-pce / Box 14-tlg.

063 913 01

1044

40 07157 53077 6

(12 x)

Blade / Klinge

2,5 x 0,4 / 3,0 x 0,5 / 3,5 x 0,6 / 4,0 x 0,8 / 5,5 x 1,0 / 6,5 x 1,2

PH 1 / PH 2

PZ 2

Torx 10 / Torx 15 / Torx 20

(1 x)

Handle / Griff 95 x 32 mm

(1 x)

Precision Cap / Drehkappe

StrongBox 230mm x 130mm x 56mm

063

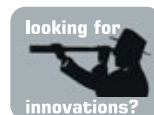

AC 1000V
IEC 60900 : 2004



Item No



EAN-Code

Zip-Bag 19-pcs/ Reißverschlussstasche 19-tlg.

063 919 04

1550

40 07157 60353 1

(14 x)

Blade / Klinge

2,5 x 0,4 / 3,0 x 0,5 / 3,5 x 0,6 / 4,0 x 0,8 / 5,5 x 1,0 / 6,5 x 1,2

PH 1 / PH 2

PZ 2

Torx 10 / Torx 15 / Torx 20

H 2

Z 2

(1 x)

Handle / Griff 95 x 32 mm

(1 x)

Precision Cap / Drehkappe

(1 x)

Combination Pliers / Kombizange 180 mm

(1 x)

Diagonal Nippers / Seitenschneider 160 mm

(1 x)

Mains testing Screwdriver / Spannungsprüfer 3,0 mm x 70 mm

(VDE 0680/6, 150-250 Volt)

Nylon bag / Nylon Tasche 310mm, 190 mm, 70 mm

063



AC 1000V
IEC 60900 : 2004



			Item No		EAN-Code
2,5 x 0,4	75 mm	1	063 025 04	30	40 07157 51721 0
3,0 x 0,5	100 mm	1	063 030 04	34	40 07157 51723 4
3,5 x 0,6	100 mm	1	063 035 04	37	40 07157 51725 8
4,0 x 0,8	100 mm	1	063 040 04	37	40 07157 51727 2
5,5 x 1,0	100 mm	1	063 055 04	45	40 07157 51729 6
6,5 x 1,2	100 mm	1	063 065 04	53	40 07157 51731 9



PH 1	80 mm	1	063 102 04	48	40 07157 51733 3
PH 2	100 mm	1	063 203 04	57	40 07157 51735 7



PZ 1	80 mm	1	063 102 14	41	40 07157 51737 1
PZ 2	100 mm	1	063 203 14	57	40 07157 51739 5



Torx 8	100 mm	1	063 083 04	35	40 07157 51741 8
Torx 10	100 mm	1	063 103 04	37	40 07157 51743 2
Torx 15	100 mm	1	063 153 04	37	40 07157 51745 6
Torx 20	100 mm	1	063 203 24	41	40 07157 51747 0



H 1	80 mm	1	063 112 04	48	40 07157 51887 3
H 2	100 mm	1	063 223 04	57	40 07157 51889 7



Z 1	80 mm	1	063 112 14	41	40 07157 51891 0
Z 2	100 mm	1	063 223 14	57	40 07157 51893 4



SQ0	100 mm	1	063 000 04	34	40 07157 53089 9
SQ1	100 mm	1	063 100 04	37	40 07157 53091 2
SQ2	100 mm	1	063 200 04	57	40 07157 53093 6
SQ3	100 mm	1	063 300 04	57	40 07157 53095 0

063



Handle / Griff

Item No

063 105 00



EAN-Code

42

40 07157 51749 4

Bits Challenger



Diamond coated



020 C 6,3



						Item No		EAN-Code
0,6 x 4,5	25 mm	C 6,3	1/4"	10	020 400 80	4	40 07157 50647 4	
1,0 x 5,5	25 mm	C 6,3	1/4"	10	020 520 80	5	40 07157 50649 8	
1,2 x 6,5	25 mm	C 6,3	1/4"	10	020 610 80	5	40 07157 50651 1	
1,2 x 8,0	25 mm	C 6,3	1/4"	10	020 800 80	7	40 07157 50653 5	

021 C 6,3



	PZ					Item No		EAN-Code
1	25 mm	C 6,3	1/4"	10	021 010 80	4	40 07157 50661 0	
2	25 mm	C 6,3	1/4"	10	021 020 80	5	40 07157 50663 4	
3	25 mm	C 6,3	1/4"	10	021 030 80	5	40 07157 50665 8	

022 C 6,3

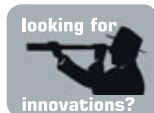

	PH					Item No		EAN-Code
1	25 mm	C 6,3	1/4"	10	022 010 80	4	40 07157 50655 9	
2	25 mm	C 6,3	1/4"	10	022 020 80	5	40 07157 50657 3	
3	25 mm	C 6,3	1/4"	10	022 030 80	5	40 07157 50659 7	

026 C 6,3



Torx				Item No		EAN-Code
10	25 mm	C 6,3 1/4"	10	026 100 80	4	40 07157 50667 2
15	25 mm	C 6,3 1/4"	10	026 150 80	4	40 07157 50669 6
20	25 mm	C 6,3 1/4"	10	026 200 80	4	40 07157 50671 9
25	25 mm	C 6,3 1/4"	10	026 250 80	5	40 07157 50673 3
30	25 mm	C 6,3 1/4"	10	026 300 80	5	40 07157 50675 7
40	25 mm	C 6,3 1/4"	10	026 400 80	6	40 07157 50677 1

031 E 6,3

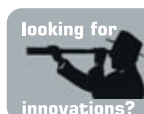

PZ				Item No		EAN-Code
1	50 mm	E 6,3 1/4"	10	031 015 80	9	40 07157 50685 6
2	50 mm	E 6,3 1/4"	10	031 025 80	10	40 07157 50687 0
3	50 mm	E 6,3 1/4"	10	031 035 80	11	40 07157 50689 4

032 E 6,3



PH				Item No		EAN-Code
1	50 mm	E 6,3 1/4"	10	032 015 80	9	40 07157 50679 5
2	50 mm	E 6,3 1/4"	10	032 025 80	11	40 07157 50681 8
3	50 mm	E 6,3 1/4"	10	032 035 80	11	40 07157 50683 2

Bits TiN Plus

TiN (>90 HRC)

SX 75 (>60 HRC)



020 C 6,3 TiN



0,8 x 5,0	25 mm	C 6,3	1/4"	10	020 500 70	5	40 07157 30907 5					
1,0 x 5,5	25 mm	C 6,3	1/4"	10	020 520 70	5	40 07157 30911 2					
1,2 x 6,5	25 mm	C 6,3	1/4"	10	020 610 70	5	40 07157 30916 7					
1,2 x 8,0	25 mm	C 6,3	1/4"	10	020 800 70	6	40 07157 30921 1					

021 C 6,3 TiN



1	25 mm	C 6,3	1/4"	10	021 010 70	5	40 07157 10313 0					
2	25 mm	C 6,3	1/4"	10	021 020 70	5	40 07157 10314 7					
3	25 mm	C 6,3	1/4"	10	021 030 70	5	40 07157 10315 4					

022 C 6,3 TiN



1	25 mm	C 6,3	1/4"	10	022 010 70	5	40 07157 10316 1					
2	25 mm	C 6,3	1/4"	10	022 020 70	5	40 07157 10317 8					
3	25 mm	C 6,3	1/4"	10	022 030 70	6	40 07157 10318 5					

022 C 6,3 TiN



2	25 mm	C 6,3	1/4"	10	022 002 70	5	40 07157 52471 3					

extra slim



026 C 6,3 TiN



Torx				Item No		EAN-Code
6	25 mm	C 6,3 1/4"	10	026 060 70	4	40 07157 50212 4
7	25 mm	C 6,3 1/4"	10	026 070 70	4	40 07157 50214 8
8	25 mm	C 6,3 1/4"	10	026 080 70	4	40 07157 50216 2
9	25 mm	C 6,3 1/4"	10	026 090 70	4	40 07157 50218 6
10	25 mm	C 6,3 1/4"	10	026 100 70	5	40 07157 50220 9
15	25 mm	C 6,3 1/4"	10	026 150 70	5	40 07157 50222 3
20	25 mm	C 6,3 1/4"	10	026 200 70	5	40 07157 50224 7
25	25 mm	C 6,3 1/4"	10	026 250 70	5	40 07157 50226 1
27	25 mm	C 6,3 1/4"	10	026 270 70	5	40 07157 50228 5
30	25 mm	C 6,3 1/4"	10	026 300 70	6	40 07157 50230 8
40	25 mm	C 6,3 1/4"	10	026 400 70	6	40 07157 50232 2
45	25 mm	C 6,3 1/4"	10	026 450 70	7	40 07157 50234 6

021 C 6,3 TiN



PZ				Item No		EAN-Code
2	50 mm	C 6,3 1/4"	10	021 025 70	11	40 07157 30930 3
3	50 mm	C 6,3 1/4"	10	021 035 70	13	40 07157 30934 1

022 C 6,3 TiN



PH				Item No		EAN-Code
2	50 mm	C 6,3 1/4"	10	022 025 70	11	40 07157 30945 7
3	50 mm	C 6,3 1/4"	10	022 035 70	12	40 07157 30949 5

030 E 6,3 TiN



						Item No		EAN-Code
0,8 x 5,0	50 mm	E 6,3	1/4"	10		030 505 70	10	40 07157 30780 4
1,0 x 5,5	50 mm	E 6,3	1/4"	10		030 525 70	10	40 07157 30785 9
1,2 x 6,5	50 mm	E 6,3	1/4"	10		030 615 70	11	40 07157 30792 7
1,2 x 8,0	50 mm	E 6,3	1/4"	10		030 805 70	13	40 07157 30798 9

031 E 6,3 TiN



PZ



						Item No		EAN-Code
1	50 mm	E 6,3	1/4"	10		031 015 70	9	40 07157 30801 6
2	50 mm	E 6,3	1/4"	10		031 025 70	11	40 07157 30806 1
3	50 mm	E 6,3	1/4"	10		031 035 70	12	40 07157 30813 9

032 E 6,3 TiN



PH



						Item No		EAN-Code
1	50 mm	E 6,3	1/4"	10		032 015 70	9	40 07157 30818 4
2	50 mm	E 6,3	1/4"	10		032 025 70	11	40 07157 30824 5
3	50 mm	E 6,3	1/4"	10		032 035 70	12	40 07157 30831 3

036 E 6,3 TiN



Torx



						Item No		EAN-Code
10	50 mm	E 6,3	1/4"	10		036 105 70	8	4007157 32372 9
15	50 mm	E 6,3	1/4"	10		036 155 70	9	4007157 32374 3
20	50 mm	E 6,3	1/4"	10		036 205 70	9	4007157 32376 7
25	50 mm	E 6,3	1/4"	10		036 255 70	9	4007157 32378 1
30	50 mm	E 6,3	1/4"	10		036 305 70	11	4007157 32380 4
40	50 mm	E 6,3	1/4"	10		036 405 70	12	4007157 32382 8

030
E 6,3
TiN



						Item No		EAN-Code
0,6 x 3,5	73 mm	E 6,3	1/4"	5	030 317 70	10	40 07157 30774 3	
0,8 x 4,0	73 mm	E 6,3	1/4"	5	030 417 70	10	40 07157 30776 7	
0,8 x 5,0	73 mm	E 6,3	1/4"	5	030 507 70	13	40 07157 30782 8	
1,0 x 5,5	73 mm	E 6,3	1/4"	5	030 557 70	14	40 07157 30789 7	
1,2 x 6,5	73 mm	E 6,3	1/4"	5	030 657 70	17	40 07157 30796 5	

031
E 6,3
TiN



PZ



					Item No		EAN-Code
1	73 mm	E 6,3	1/4"	5	031 017 70	12	40 07157 30803 0
2	73 mm	E 6,3	1/4"	5	031 027 70	16	40 07157 30808 5

032
E 6,3
TiN

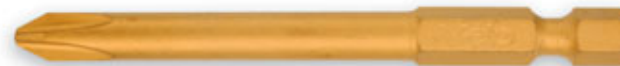

PH



					Item No		EAN-Code
1	73 mm	E 6,3	1/4"	5	032 017 70	12	40 07157 30820 7
2	73 mm	E 6,3	1/4"	5	032 027 70	16	40 07157 30826 9

Bits Industrial



020 C 6,3



Item No



EAN-Code

0,5 x 4,0	25 mm	C 6,3	1/4"	10	020 210 10	5	40 07157 24037 8
0,5 x 3,0	25 mm	C 6,3	1/4"	10	020 300 10	4	40 07157 30066 9
0,6 x 3,5	25 mm	C 6,3	1/4"	10	020 310 10	4	40 07157 30070 6
0,6 x 4,5	25 mm	C 6,3	1/4"	10	020 400 10	5	40 07157 30904 4
0,8 x 4,0	25 mm	C 6,3	1/4"	10	020 410 10	5	40 07157 30079 9
0,8 x 5,0	25 mm	C 6,3	1/4"	10	020 500 10	5	40 07157 30089 8
0,8 x 5,5	25 mm	C 6,3	1/4"	10	020 510 10	5	40 07157 30097 3
1,0 x 5,5	25 mm	C 6,3	1/4"	10	020 520 10	5	40 07157 30105 5
1,0 x 6,0	25 mm	C 6,3	1/4"	10	020 600 10	5	40 07157 30112 3
1,2 x 6,5	25 mm	C 6,3	1/4"	10	020 610 10	6	40 07157 30119 2
1,2 x 8,0	25 mm	C 6,3	1/4"	10	020 800 10	7	40 07157 30918 1

020 C 6,3



Item No



EAN-Code

0,6 x 3,5	39 mm	C 6,3	1/4"	10	020 353 10	5	40 07157 30076 8
0,6 x 4,5	39 mm	C 6,3	1/4"	10	020 423 10	7	40 07157 30086 7
0,8 x 4,0	39 mm	C 6,3	1/4"	10	020 413 10	6	40 07157 30084 3
0,8 x 5,0	39 mm	C 6,3	1/4"	10	020 503 10	7	40 07157 30095 9
0,8 x 5,5	39 mm	C 6,3	1/4"	10	020 513 10	8	40 07157 30103 1
1,0 x 5,5	39 mm	C 6,3	1/4"	10	020 523 10	8	40 07157 30110 9
1,0 x 6,0	39 mm	C 6,3	1/4"	10	020 603 10	8	40 07157 30117 8
1,2 x 6,5	39 mm	C 6,3	1/4"	10	020 613 10	9	40 07157 30125 3
1,2 x 8,0	39 mm	C 6,3	1/4"	10	020 803 10	12	40 07157 30128 4
1,6 x 8,0	39 mm	C 6,3	1/4"	10	020 813 10	12	40 07157 30133 8
1,6 x 10,0	39 mm	C 6,3	1/4"	10	020 103 10	14	40 07157 30064 5

021 C 6,3



PZ	↔	⬠	⬠	Item No	📦	EAN-Code
0	25 mm	C 6,3	1/4"	10	021 000 10	4 40 07157 24025 5
1	25 mm	C 6,3	1/4"	10	021 010 10	5 40 07157 30159 8
1 (100)	25 mm	C 6,3	1/4"	1	021 010 17	500 40 07157 30925 9
2	25 mm	C 6,3	1/4"	10	021 020 10	5 40 07157 30169 7
2 (100)	25 mm	C 6,3	1/4"	1	021 020 17	520 40 07157 30928 0
3	25 mm	C 6,3	1/4"	10	021 030 10	6 40 07157 30180 2
3 (100)	25 mm	C 6,3	1/4"	1	021 030 17	540 40 07157 31353 9
4	32 mm	C 6,3	1/4"	10	021 042 10	12 40 07157 30190 1

022 C 6,3



PH	↔	⬠	⬠	Item No	€	📦	EAN-Code
0	25 mm	C 6,3	1/4"	10	022 000 10	4	40 07157 30937 2
1	25 mm	C 6,3	1/4"	10	022 010 10	5	40 07157 30193 2
1 (100)	25 mm	C 6,3	1/4"	1	022 010 17	470	40 07157 30940 2
2	25 mm	C 6,3	1/4"	10	022 020 10	5	40 07157 30205 2
2 (100)	25 mm	C 6,3	1/4"	1	022 020 17	510	40 07157 30943 3
3	25 mm	C 6,3	1/4"	10	022 030 10	6	40 07157 30218 2
3 (100)	25 mm	C 6,3	1/4"	1	022 030 17	560	40 07157 31351 5
4	32 mm	C 6,3	1/4"	10	022 042 10	11	40 07157 30229 8

021 C 6,3



PZ	↔	⬠	⬠	Item No	📦	EAN-Code
2	50 mm	C 6,3	1/4"	10	021 025 10	11 40 07157 30178 9
3	50 mm	C 6,3	1/4"	10	021 035 10	12 40 07157 30188 8

022 C 6,3



PH	↔	⬠	⬠	Item No	📦	EAN-Code
2	50 mm	C 6,3	1/4"	10	022 025 10	11 40 07157 30216 8
3	50 mm	C 6,3	1/4"	10	022 035 10	12 40 07157 30227 4

024 C 6,3



mm					Item No		EAN-Code
2,0	25 mm	C 6,3	1/4"	10	024 200 10	5	40 07157 30952 5
2,5	25 mm	C 6,3	1/4"	10	024 250 10	5	40 07157 30253 3
3,0	25 mm	C 6,3	1/4"	10	024 300 10	5	40 07157 30255 7
4,0	25 mm	C 6,3	1/4"	10	024 400 10	5	40 07157 30257 1
5,0	25 mm	C 6,3	1/4"	10	024 500 10	6	40 07157 30259 5
6,0	25 mm	C 6,3	1/4"	10	024 600 10	7	40 07157 30261 8
8,0	30 mm	C 6,3	1/4"	10	024 800 10	9	40 07157 30263 2

025 C 6,3



sq					Item No		EAN-Code
0	25 mm	C 6,3	1/4"	10	025 000 10	4	40 07157 50350 3
1	25 mm	C 6,3	1/4"	10	025 100 10	4	40 07157 50352 7
2	25 mm	C 6,3	1/4"	10	025 200 10	5	40 07157 50354 1
3	25 mm	C 6,3	1/4"	10	025 300 10	5	40 07157 50356 5

026 C 6,3



Torx					Item No		EAN-Code
5	25 mm	C 6,3	1/4"	10	026 050 10	4	40 07157 50779 2
6	25 mm	C 6,3	1/4"	10	026 060 10	4	40 07157 30953 2
7	25 mm	C 6,3	1/4"	10	026 070 10	4	40 07157 30954 9
8	25 mm	C 6,3	1/4"	10	026 080 10	4	40 07157 30955 6
9	25 mm	C 6,3	1/4"	10	026 090 10	4	40 07157 30956 3
10	25 mm	C 6,3	1/4"	10	026 100 10	5	40 07157 30957 0
10 (100)	25 mm	C 6,3	1/4"	1	026 100 17	460	40 07157 31561 8
15	25 mm	C 6,3	1/4"	10	026 150 10	5	40 07157 30959 4
15 (100)	25 mm	C 6,3	1/4"	1	026 150 17	480	40 07157 31563 2
20	25 mm	C 6,3	1/4"	10	026 200 10	5	40 07157 30961 7
20 (100)	25 mm	C 6,3	1/4"	1	026 200 17	510	40 07157 31565 6
25	25 mm	C 6,3	1/4"	10	026 250 10	5	40 07157 30963 1
25 (100)	25 mm	C 6,3	1/4"	1	026 250 17	530	40 07157 31567 0
27	25 mm	C 6,3	1/4"	10	026 270 10	5	40 07157 30965 5
30	25 mm	C 6,3	1/4"	10	026 300 10	6	40 07157 30967 9
40	25 mm	C 6,3	1/4"	10	026 400 10	6	40 07157 30969 3
45	25 mm	C 6,3	1/4"	10	026 450 10	7	40 07157 32076 6

027 C 6,3



TorxTR					Item No		EAN-Code
7	25 mm	C 6,3	1/4"	10	027 070 10	4	40 07157 50771 6
8	25 mm	C 6,3	1/4"	10	027 080 10	4	40 07157 50773 0
9	25 mm	C 6,3	1/4"	10	027 090 10	4	40 07157 50775 4
10	25 mm	C 6,3	1/4"	10	027 100 10	5	40 07157 30971 6
15	25 mm	C 6,3	1/4"	10	027 150 10	5	40 07157 30972 3
20	25 mm	C 6,3	1/4"	10	027 200 10	5	40 07157 30973 0
25	25 mm	C 6,3	1/4"	10	027 250 10	5	40 07157 30974 7
27	25 mm	C 6,3	1/4"	10	027 270 10	5	40 07157 30975 4
30	25 mm	C 6,3	1/4"	10	027 300 10	6	40 07157 30976 1
40	25 mm	C 6,3	1/4"	10	027 400 10	6	40 07157 30977 8

023 C 6,3



TorxPlus					Item No		EAN-Code
IP 6	25 mm	C 6,3	1/4"	10	023 060 10	4	40 07157 51341 0
IP 7	25 mm	C 6,3	1/4"	10	023 070 10	4	40 07157 51343 4
IP 8	25 mm	C 6,3	1/4"	10	023 080 10	4	40 07157 51345 8
IP 9	25 mm	C 6,3	1/4"	10	023 090 10	4	40 07157 51347 2
IP 10	25 mm	C 6,3	1/4"	10	023 100 10	5	40 07157 51349 6
IP 15	25 mm	C 6,3	1/4"	10	023 150 10	5	40 07157 51351 9
IP 20	25 mm	C 6,3	1/4"	10	023 200 10	5	40 07157 51353 3
IP 25	25 mm	C 6,3	1/4"	10	023 250 10	5	40 07157 51355 7
IP 27	25 mm	C 6,3	1/4"	10	023 270 10	6	40 07157 51357 1
IP 30	25 mm	C 6,3	1/4"	10	023 300 10	6	40 07157 51359 5
IP 40	25 mm	C 6,3	1/4"	10	023 400 10	6	40 07157 51361 8

028 C 6,3



Clutch					Item No		EAN-Code
5/32"	25 mm	C 6,3	1/4"	10	028 930 10	5	40 07157 52271 9
1/4"	25 mm	C 6,3	1/4"	10	028 940 10	6	40 07157 52273 3

028 C 6,3



XZN				Item No		EAN-Code
M 4	25 mm	C 6,3 1/4"	10	028 040 10	5	40 07157 50360 2
M 5	25 mm	C 6,3 1/4"	10	028 050 10	5	40 07157 50362 6
M 6	25 mm	C 6,3 1/4"	10	028 060 10	6	40 07157 50364 0
M 8	25 mm	C 6,3 1/4"	10	028 080 10	6	40 07157 50366 4
M10	25 mm	C 6,3 1/4"	10	028 100 10	8	40 07157 50368 8

029 C 6,3



TS				Item No		EAN-Code
0	25 mm	C 6,3 1/4"	10	029 000 10	5	40 07157 50370 1
1	25 mm	C 6,3 1/4"	10	029 010 10	6	40 07157 50372 5
2	25 mm	C 6,3 1/4"	10	029 020 10	5	40 07157 50374 9
3	25 mm	C 6,3 1/4"	10	029 030 10	5	40 07157 50376 3
4	25 mm	C 6,3 1/4"	10	029 040 10	5	40 07157 50378 7
5	25 mm	C 6,3 1/4"	10	029 050 10	5	40 07157 50380 0
6	25 mm	C 6,3 1/4"	10	029 060 10	5	40 07157 50382 4
8	25 mm	C 6,3 1/4"	10	029 080 10	6	40 07157 50536 1
10	25 mm	C 6,3 1/4"	10	029 100 10	6	40 07157 50819 5

029 C 6,3



Tri-Wing				Item No		EAN-Code
1	25 mm	C 6,3 1/4"	10	029 510 10	5	40 07157 52255 9
2	25 mm	C 6,3 1/4"	10	029 520 10	5	40 07157 52257 3
3	25 mm	C 6,3 1/4"	10	029 530 10	5	40 07157 52259 7
4	25 mm	C 6,3 1/4"	10	029 540 10	5	40 07157 52261 0
5	25 mm	C 6,3 1/4"	10	029 550 10	5	40 07157 52263 4

020 C 6,3



Spanner				Item No		EAN-Code
6	25 mm	C 6,3 1/4"	10	020 906 10	5	40 07157 52265 8
8	25 mm	C 6,3 1/4"	10	020 908 10	5	40 07157 52267 2
10	25 mm	C 6,3 1/4"	10	020 910 10	5	40 07157 52269 6

030 E 6,3



					Item No		EAN-Code
0,5 x 3,0	50 mm	E 6,3	1/4"	10	030 305 10	8	40 07157 30772 9
0,6 x 3,5	50 mm	E 6,3	1/4"	10	030 315 10	8	40 07157 30275 5
0,8 x 4,0	50 mm	E 6,3	1/4"	10	030 415 10	9	40 07157 30277 9
0,6 x 4,5	50 mm	E 6,3	1/4"	10	030 455 10	9	40 07157 30779 8
0,8 x 5,0	50 mm	E 6,3	1/4"	10	030 505 10	9	40 07157 30280 9
0,8 x 5,5	50 mm	E 6,3	1/4"	10	030 515 10	10	40 07157 30283 0
1,0 x 5,5	50 mm	E 6,3	1/4"	10	030 525 10	10	40 07157 30285 4
1,0 x 6,0	50 mm	E 6,3	1/4"	10	030 605 10	11	40 07157 30287 8
1,2 x 6,5	50 mm	E 6,3	1/4"	10	030 615 10	12	40 07157 30290 8
1,2 x 8,0	50 mm	E 6,3	1/4"	10	030 805 10	14	40 07157 30292 2
1,6 x 8,0	50 mm	E 6,3	1/4"	10	030 815 10	14	40 07157 30294 6
1,6 x 10,0	50 mm	E 6,3	1/4"	10	030 105 10	17	40 07157 30272 4

031 E 6,3



PZ					Item No		EAN-Code
1	50 mm	E 6,3	1/4"	10	031 015 10	9	40 07157 30309 7
2	50 mm	E 6,3	1/4"	10	031 025 10	11	40 07157 30312 7
3	50 mm	E 6,3	1/4"	10	031 035 10	11	40 07157 30315 8

032 E 6,3



PH					Item No		EAN-Code
0	50 mm	E 6,3	1/4"	10	032 005 10	8	40 07157 51015 0
1	50 mm	E 6,3	1/4"	10	032 015 10	9	40 07157 30317 2
2	50 mm	E 6,3	1/4"	10	032 025 10	11	40 07157 30320 2
3	50 mm	E 6,3	1/4"	10	032 035 10	12	40 07157 30323 3

033 E 6,3



TorxPlus					Item No		EAN-Code
IP 10	50 mm	E 6,3	1/4"	10	033 105 10	8	40 07157 51363 2
IP 15	50 mm	E 6,3	1/4"	10	033 155 10	9	40 07157 51365 6
IP 20	50 mm	E 6,3	1/4"	10	033 205 10	9	40 07157 51367 0
IP 25	50 mm	E 6,3	1/4"	10	033 255 10	10	40 07157 51369 4
IP 30	50 mm	E 6,3	1/4"	10	033 305 10	11	40 07157 51371 7

034 E 6,3



mm				Item No		EAN-Code
2,5	50 mm	E 6,3 1/4"	10	034 255 10	11	40 07157 30325 7
3,0	50 mm	E 6,3 1/4"	10	034 305 10	11	40 07157 30327 1
4,0	50 mm	E 6,3 1/4"	10	034 405 10	12	40 07157 30329 5
5,0	50 mm	E 6,3 1/4"	10	034 505 10	12	40 07157 30331 8
6,0	50 mm	E 6,3 1/4"	10	034 605 10	13	40 07157 30333 2
8,0	50 mm	E 6,3 1/4"	10	034 805 10	17	40 07157 31878 7

036 E 6,3



Torx				Item No		EAN-Code
5	50 mm	E 6,3 1/4"	10	036 055 10	7	40 07157 50973 4
6	50 mm	E 6,3 1/4"	10	036 065 10	7	40 07157 51375 5
7	50 mm	E 6,3 1/4"	10	036 075 10	7	40 07157 51377 9
8	50 mm	E 6,3 1/4"	10	036 085 10	8	40 07157 30834 4
9	50 mm	E 6,3 1/4"	10	036 095 10	8	40 07157 30835 1
10	50 mm	E 6,3 1/4"	10	036 105 10	9	40 07157 30836 8
15	50 mm	E 6,3 1/4"	10	036 155 10	8	40 07157 24026 2
20	50 mm	E 6,3 1/4"	10	036 205 10	9	40 07157 30839 9
25	50 mm	E 6,3 1/4"	10	036 255 10	9	40 07157 30841 2
27	50 mm	E 6,3 1/4"	10	036 275 10	9	40 07157 30843 6
30	50 mm	E 6,3 1/4"	10	036 305 10	11	40 07157 30845 0
40	50 mm	E 6,3 1/4"	10	036 405 10	12	40 07157 30847 4



030 E 6,3



					Item No		EAN-Code
0,5 x 3,0	73 mm	E 6,3	1/4"	5	030 307 10	9	40 07157 30274 8
0,6 x 3,5	73 mm	E 6,3	1/4"	5	030 317 10	11	40 07157 30773 6
0,8 x 4,0	73 mm	E 6,3	1/4"	5	030 417 10	11	40 07157 30279 3
1,0 x 5,5	73 mm	E 6,3	1/4"	5	030 527 10	14	40 07157 30787 3
1,2 x 6,5	73 mm	E 6,3	1/4"	5	030 617 10	17	40 07157 30794 1

031 E 6,3



PZ



					Item No		EAN-Code
1	73 mm	E 6,3	1/4"	5	031 017 10	12	40 07157 30311 0
2	73 mm	E 6,3	1/4"	5	031 027 10	16	40 07157 30314 1
3	73 mm	E 6,3	1/4"	5	031 037 10	18	40 07157 30815 3

032 E 6,3



PH



					Item No		EAN-Code
1	73 mm	E 6,3	1/4"	5	032 017 10	12	40 07157 30319 6
2	73 mm	E 6,3	1/4"	5	032 027 10	16	40 07157 30322 6
3	73 mm	E 6,3	1/4"	5	032 037 10	18	40 07157 30833 7

035 E 6,3



sq					Item No		EAN-Code
0	73 mm	E 6,3	1/4"	5	035 007 10	17	40 07157 31520 5
1	73 mm	E 6,3	1/4"	5	035 017 10	17	40 07157 31522 9
2	73 mm	E 6,3	1/4"	5	035 027 10	18	40 07157 31524 3
3	73 mm	E 6,3	1/4"	5	035 037 10	18	40 07157 31526 7

036 E 6,3



Torx					Item No		EAN-Code
10	73 mm	E 6,3	1/4"	3	036 107 10	10	40 07157 30837 5
15	73 mm	E 6,3	1/4"	3	036 157 10	11	40 07157 30838 2
20	73 mm	E 6,3	1/4"	3	036 207 10	12	40 07157 30840 5
25	73 mm	E 6,3	1/4"	3	036 257 10	13	40 07157 30842 9
27	73 mm	E 6,3	1/4"	3	036 277 10	14	40 07157 30844 3
30	73 mm	E 6,3	1/4"	3	036 307 10	17	40 07157 30846 7
40	73 mm	E 6,3	1/4"	3	036 407 10	19	40 07157 30848 1

031 E 6,3



Z (+/-)					Item No		EAN-Code
1	73 mm	E 6,3	1/4"	5	031 101 10	12	40 07157 51883 5
2	73 mm	E 6,3	1/4"	5	031 202 10	16	40 07157 51885 9

032 E 6,3



H (+/-)					Item No		EAN-Code
1	73 mm	E 6,3	1/4"	5	032 101 10	12	40 07157 51879 8
2	73 mm	E 6,3	1/4"	5	032 202 10	16	40 07157 51881 1

030 E 6,3



					Item No		EAN-Code
0,8 x 4,0	100 mm	E 6,3	1/4"	3	030 418 10	14	40 07157 30778 1
1,0 x 5,5	100 mm	E 6,3	1/4"	3	030 528 10	19	40 07157 30788 0
1,2 x 6,5	100 mm	E 6,3	1/4"	3	030 618 10	24	40 07157 30795 8
1,2 x 8,0	100 mm	E 6,3	1/4"	3	030 818 10	33	40 07157 30800 9

031 E 6,3



PZ



					Item No		EAN-Code
1	100 mm	E 6,3	1/4"	3	031 018 10	15	40 07157 30805 4
2	100 mm	E 6,3	1/4"	3	031 028 10	22	40 07157 30810 8
3	100 mm	E 6,3	1/4"	3	031 038 10	25	40 07157 30816 0

032 E 6,3



PH



					Item No		EAN-Code
1	100 mm	E 6,3	1/4"	3	032 018 10	15	40 07157 30822 1
2	100 mm	E 6,3	1/4"	3	032 028 10	22	40 07157 30828 3

031 E 6,3



PZ



					Item No		EAN-Code
1	150 mm	E 6,3	1/4"	3	031 019 10	22	40 07157 30752 1
2	150 mm	E 6,3	1/4"	3	031 029 10	33	40 07157 30812 2
3	150 mm	E 6,3	1/4"	3	031 039 10	39	40 07157 30817 7

032 E 6,3



PH









					Item No		EAN-Code
1	150 mm	E 6,3	1/4"	3	032 019 10	22	40 07157 30823 8
2	150 mm	E 6,3	1/4"	3	032 029 10	33	40 07157 30830 6





Challenger



					Item No		EAN-Code
	1 x	5,5 x 1,0	25 mm	C 6,3	10	020 520 86	13 40 07157 52201 6
	1 x	6,5 x 1,2	25 mm	C 6,3	10	020 610 86	13 40 07157 52203 0
	1 x	8,0 x 1,2	25 mm	C 6,3	10	020 800 86	14 40 07157 52205 4
	1 x	PZ 1	25 mm	C 6,3	10	021 010 86	12 40 07157 52185 9
	2 x	PZ 1	25 mm	C 6,3	10	021 012 86	17 40 07157 51033 4
	2 x	PZ 2	25 mm	C 6,3	10	021 022 86	18 40 07157 51035 8
	1 x	PZ 3	25 mm	C 6,3	10	021 030 86	13 40 07157 52187 3
	2 x	PZ 3	25 mm	C 6,3	10	021 032 86	18 40 07157 51037 2
	3 x 1	PZ 1 / PZ 2 / PZ 3	25 mm	C 6,3	10	021 932 86	21 40 07157 52179 8
	1 x	PH 1	25 mm	C 6,3	10	022 010 86	12 40 07157 52181 1
	2 x	PH 2	25 mm	C 6,3	10	022 022 86	17 40 07157 51039 6
	1 x	PH 3	25 mm	C 6,3	10	022 030 86	13 40 07157 52183 5
	3 x 1	PH 1 / PH 2 / PH 3	25 mm	C 6,3	10	022 931 86	22 40 07157 52177 4
	1 x	Torx 10	25 mm	C 6,3	10	026 100 86	11 40 07157 52189 7
	1 x	Torx 15	25 mm	C 6,3	10	026 150 86	11 40 07157 52191 0
	2 x	Torx 20	25 mm	C 6,3	10	026 202 86	16 40 07157 52193 4
	2 x	Torx 25	25 mm	C 6,3	10	026 252 86	17 40 07157 52195 8
	1 x	Torx 30	25 mm	C 6,3	10	026 300 86	18 40 07157 52197 2
	1 x	Torx 40	25 mm	C 6,3	10	026 400 86	14 40 07157 52199 6
	3 x 1	Torx 15 / Torx 20 / Torx 25	25 mm	C 6,3	10	026 933 86	20 40 07157 52175 0
	1 x	PZ 2	50 mm	E 6,3	10	031 025 86	18 40 07157 52209 2
	1 x	PH 1	50 mm	E 6,3	10	032 015 86	18 40 07157 52213 9
	1 x	PH 2	50 mm	E 6,3	10	032 025 86	17 40 07157 52211 5

















TiN Plus

					Item No		EAN-Code
⊖	2 x	5,0 x 0,8	25 mm	C 6,3	10	020 500 67	18 40 07157 32134 3
	2 x	5,5 x 1,0	25 mm	C 6,3	10	020 520 67	18 40 07157 31892 3
	2 x	6,5 x 1,2	25 mm	C 6,3	10	020 610 67	19 40 07157 31894 7
	2 x	8,0 x 1,2	25 mm	C 6,3	10	020 800 67	21 40 07157 31896 1
	3 x 1	5,0 x 0,8 / 5,5 x 1,0 / 6,5 x 1,2	25 mm	C 6,3	10	020 931 67	24 40 07157 32136 7
	3 x 1	5,5 x 1,0 / 6,5 x 1,2 / 8,0 x 1,2	25 mm	C 6,3	10	020 932 67	25 40 07157 32138 1
+	2 x	PZ 1	25 mm	C 6,3	10	021 010 67	18 40 07157 31898 5
	2 x 1	PZ 1 / PZ 2	25 mm	C 6,3	10	021 012 67	18 40 07157 31504 5
	5 x	PZ 2	25 mm	C 6,3	10	021 020 57	33 40 07157 31508 3
	2 x	PZ 2	25 mm	C 6,3	10	021 020 67	18 40 07157 31304 1
	2 x 1	PZ 2 / PZ 3	25 mm	C 6,3	10	021 023 67	18 40 07157 31506 9
	2 x	PZ 3	25 mm	C 6,3	10	021 030 67	18 40 07157 31303 4
	3 x 1	PZ 1 / PZ 2 / PZ 3	25 mm	C 6,3	10	021 932 67	22 40 07157 52171 2
⊕	2 x	PH 1	25 mm	C 6,3	10	022 010 67	17 40 07157 31900 5
	2 x 1	PH 1 / PH 2	25 mm	C 6,3	10	022 012 67	18 40 07157 31490 1
	5 x	PH 2	25 mm	C 6,3	10	022 020 57	33 40 07157 31494 9
	2 x	PH 2	25 mm	C 6,3	10	022 020 67	18 40 07157 31302 7
	2 x	PH 3	25 mm	C 6,3	10	022 030 67	19 40 07157 32082 7
	3 x 1	PH 1 / PH 2 / PH 3	25 mm	C 6,3	10	022 931 67	23 40 07157 32142 8
⊗	2 x	Torx 10	25 mm	C 6,3	10	026 100 67	16 40 07157 52159 0
	2 x	Torx 15	25 mm	C 6,3	10	026 150 67	17 40 07157 52161 3
	2 x	Torx 20	25 mm	C 6,3	10	026 200 67	17 40 07157 52163 7
	2 x	Torx 25	25 mm	C 6,3	10	026 250 67	18 40 07157 52165 1
	2 x	Torx 30	25 mm	C 6,3	10	026 300 67	19 40 07157 52167 5
	2 x	Torx 40	25 mm	C 6,3	10	026 400 67	20 40 07157 52169 9
	3 x 1	Torx 15 / Torx 20 / Torx 25	25 mm	C 6,3	10	026 933 67	22 40 07157 52173 6
⊖	2 x	5,5 x 1,0	50 mm	E 6,3	10	030 525 67	28 40 07157 52207 8
	2 x	6,5 x 1,2	50 mm	E 6,3	10	030 615 67	31 40 07157 31906 7
	2 x	8,0 x 1,2	50 mm	E 6,3	10	030 805 67	35 40 07157 31908 1
+	2 x	PZ 1	50 mm	E 6,3	10	031 015 67	26 40 07157 31910 4
	2 x	PZ 2	50 mm	E 6,3	10	031 025 67	24 40 07157 31912 8
	2 x	PZ 3	50 mm	E 6,3	10	031 035 67	27 40 07157 31914 2
⊕	2 x	PH 1	50 mm	E 6,3	10	032 015 67	26 40 07157 31916 6
	2 x	PH 2	50 mm	E 6,3	10	032 025 67	29 40 07157 31918 0
	2 x	PH 3	50 mm	E 6,3	10	032 035 67	31 40 07157 31920 3



Industrial

						Item No		EAN-Code
	2 x	3,5 x 0,6	25 mm	C 6,3	10	020 310 36	16	40 07157 10263 8
	2 x	4,0 x 0,8	25 mm	C 6,3	10	020 410 36	17	40 07157 10264 5
	2 x	4,5 x 0,6	39 mm	C 6,3	10	020 423 36	23	40 07157 10310 9
	2 x	5,0 x 0,8	25 mm	C 6,3	10	020 500 36	18	40 07157 31890 9
	2 x	5,5 x 0,8	25 mm	C 6,3	10	020 510 36	18	40 07157 10311 6
	2 x	5,5 x 1,0	25 mm	C 6,3	10	020 520 36	18	40 07157 10265 2
	2 x	5,5 x 1,0	39 mm	C 6,3	10	020 523 36	24	40 07157 10309 3
	2 x	6,5 x 1,2	25 mm	C 6,3	10	020 610 36	19	40 07157 10266 9
	2 x	8,0 x 1,2	25 mm	C 6,3	10	020 800 36	20	40 07157 10267 6
	3 x 1	3,5 x 0,6 / 4,0 x 0,8 / 5,5 x 1,0	25 mm	C 6,3	10	020 931 16	21	40 07157 10278 2
3 x 1	6,0 x 1,0 / 6,5 x 1,2 / 8,0 x 1,2	25 mm	C 6,3	10	020 932 16	25	40 07157 10279 9	
3 x 1	4,5 x 0,6 / 5,0 x 0,8 / 6,0 x 1,0	25 mm	C 6,3	10	020 933 16	24	40 07157 32218 0	
3 x 1	6,5 x 1,2 / 7,0 x 1,2 / 8,0 x 1,2	25 mm	C 6,3	10	020 934 16	26	40 07157 32220 3	
	2 x	PZ 1	25 mm	C 6,3	10	021 010 36	17	40 07157 10275 1
	5 x	PZ 1	25 mm	C 6,3	10	021 010 56	31	40 07157 31670 7
	2 x 1	PZ 1 / PZ 2	25 mm	C 6,3	10	021 012 36	18	40 07157 31500 7
	2 x	PZ 2	25 mm	C 6,3	10	021 020 36	18	40 07157 10276 8
	5 x	PZ 2	25 mm	C 6,3	10	021 020 56	32	40 07157 10285 0
	2 x 1	PZ 2 / PZ 3	25 mm	C 6,3	10	021 023 36	18	40 07157 31502 1
	2 x	PZ 3	25 mm	C 6,3	10	021 030 36	18	40 07157 10277 5
	5 x	PZ 3	25 mm	C 6,3	10	021 030 56	33	40 07157 31668 4
	3 x 1	PZ 1 / PZ 2 / PZ 3	25 mm	C 6,3	10	021 932 16	23	40 07157 10281 2
	2 x	PH 1	25 mm	C 6,3	10	022 010 36	17	40 07157 10270 6
	5 x	PH 1	25 mm	C 6,3	10	022 010 56	30	40 07157 31666 0
	2 x 1	PH 1 / PH 2	25 mm	C 6,3	10	022 012 36	17	40 07157 31496 3
	2 x	PH 2	25 mm	C 6,3	10	022 020 36	17	40 07157 10271 3
	5 x	PH 2	25 mm	C 6,3	10	022 020 56	32	40 07157 10284 3
	2 x 1	PH 2 / PH 3	25 mm	C 6,3	10	022 023 36	18	40 07157 31498 7
	2 x	PH 3	25 mm	C 6,3	10	022 030 36	19	40 07157 10272 0
	3 x 1	PH 1 / PH 2 / PH 3	25 mm	C 6,3	10	022 931 16	23	40 07157 10280 5
	2 x	2 mm	25 mm	C 6,3	10	024 200 36	18	40 07157 31880 0
	2 x	2,5 mm	25 mm	C 6,3	10	024 250 36	18	40 07157 31882 4
	2 x	3 mm	25 mm	C 6,3	10	024 300 36	18	40 07157 31884 8
	2 x	4 mm	25 mm	C 6,3	10	024 400 36	18	40 07157 31886 2
	2 x	5 mm	25 mm	C 6,3	10	024 500 36	19	40 07157 10291 1
	2 x	6 mm	25 mm	C 6,3	10	024 600 36	21	40 07157 10290 4
	2 x	8 mm	25 mm	C 6,3	10	024 800 36	25	40 07157 31888 6
	3 x 1	3 mm / 4 mm / 5 mm	25 mm	C 6,3	10	024 931 16	25	40 07157 32216 6
	3 x 1	2,5 mm / 3 mm / 4 mm	25 mm	C 6,3	10	024 933 16	24	40 07157 10282 9
	3 x 1	4 mm / 5 mm / 6 mm	25 mm	C 6,3	10	024 934 16	25	40 07157 10283 6

						Item No		EAN-Code
	2 x	Torx 6	25 mm	C 6,3	10	026 060 36	16	40 07157 10303 1
	2 x	Torx 7	25 mm	C 6,3	10	026 070 36	16	40 07157 10302 4
	2 x	Torx 8	25 mm	C 6,3	10	026 080 36	16	40 07157 10301 7
	2 x	Torx 9	25 mm	C 6,3	10	026 090 36	16	40 07157 10300 0
	2 x	Torx 10	25 mm	C 6,3	10	026 100 36	17	40 07157 10299 7
	2 x	Torx 15	25 mm	C 6,3	10	026 150 36	17	40 07157 10298 0
	2 x	Torx 20	25 mm	C 6,3	10	026 200 36	17	40 07157 10297 3
	2 x	Torx 25	25 mm	C 6,3	10	026 250 36	17	40 07157 10296 6
	2 x	Torx 27	25 mm	C 6,3	10	026 270 36	18	40 07157 10295 9
	2 x	Torx 30	25 mm	C 6,3	10	026 300 36	19	40 07157 10294 2
	2 x	Torx 40	25 mm	C 6,3	10	026 400 36	20	40 07157 22194 0
	3 x 1	Torx 10 / Torx 15 / Torx 20	25 mm	C 6,3	10	026 931 16	21	40 07157 32222 7
	3 x 1	Torx 25 / Torx 27 / Torx 30	25 mm	C 6,3	10	026 932 16	23	40 07157 32214 2
	3 x 1	Torx 15 / Torx 20 / Torx 25	25 mm	C 6,3	10	026 933 16	22	40 07157 52157 6
	3 x 1	Torx 10 / Torx 15 / Torx 20	50 mm	E 6,3	10	036 931 16	33	40 07157 52243 6
	3 x 1	Torx 20 / Torx 25 / Torx 30	50 mm	E 6,3	10	036 932 16	37	40 07157 52241 2
	2 x	Torx TR 7	25 mm	C 6,3	10	027 070 36	16	40 07157 51641 1
	2 x	Torx TR 8	25 mm	C 6,3	10	027 080 36	16	40 07157 51643 5
	2 x	Torx TR 9	25 mm	C 6,3	10	027 090 36	16	40 07157 51645 9
	2 x	Torx TR 10	25 mm	C 6,3	10	027 100 36	17	40 07157 51647 3
	2 x	Torx TR 15	25 mm	C 6,3	10	027 150 36	17	40 07157 51649 7
	2 x	Torx TR 20	25 mm	C 6,3	10	027 200 36	17	40 07157 51651 0
	2 x	Torx TR 25	25 mm	C 6,3	10	027 250 36	18	40 07157 51653 4
	2 x	Torx TR 27	25 mm	C 6,3	10	027 270 36	18	40 07157 51655 8
	2 x	Torx TR 30	25 mm	C 6,3	10	027 300 36	19	40 07157 51657 2
	2 x	Torx TR 40	25 mm	C 6,3	10	027 400 36	20	40 07157 51659 6
	2 x	3,0 x 0,5	73 mm	E 6,3	10	030 307 36	24	40 07157 31934 0
	2 x	3,5 x 0,6	73 mm	E 6,3	10	030 317 36	28	40 07157 10293 5
	2 x	4,0 x 0,8	73 mm	E 6,3	10	030 415 36	24	40 07157 10308 6
	2 x	5,0 x 0,8	73 mm	E 6,3	10	030 505 36	26	40 07157 31902 9
	2 x	5,5 x 0,8	73 mm	E 6,3	10	030 515 36	28	40 07157 10307 9
	2 x	5,5 x 1,0	73 mm	E 6,3	10	030 525 36	28	40 07157 31904 3
	2 x	5,5 x 1,0	73 mm	E 6,3	10	030 527 36	36	40 07157 10305 5
	2 x	6,0 x 1,0	73 mm	E 6,3	10	030 605 36	30	40 07157 51631 2
	2 x	6,5 x 1,2	73 mm	E 6,3	10	030 615 36	30	40 07157 51633 6
	2 x	8,0 x 1,2	73 mm	E 6,3	10	030 805 36	35	40 07157 51635 0
	3 x	3,5 x 0,6 / 5,5 x 0,8 / 6,5 x 1,2	73 mm	E 6,3	10	030 931 16	37	40 07157 52239 9
	2 x	PZ 1	50 mm	E 6,3	10	031 015 36	25	40 07157 51637 4
	2 x	PZ 2	50 mm	E 6,3	10	031 025 36	28	40 07157 10287 4
	2 x	PZ 2	73 mm	E 6,3	10	031 027 36	38	40 07157 10292 8
	3 x 1	PZ 1 / PZ 2 / PZ 3	50 mm	E 6,3	10	031 932 16	37	40 07157 31306 5
	2 x	PH 1	50 mm	E 6,3	10	032 015 36	25	40 07157 51639 8
	2 x	PH 1	73 mm	E 6,3	10	032 017 36	32	40 07157 50520 0
	2 x	PH 2	50 mm	E 6,3	10	032 025 36	29	40 07157 10286 7
	2 x	PH 2	73 mm	E 6,3	10	032 027 36	39	40 07157 10304 8
	3 x 1	PH 1 / PH 2 / PH 3	50 mm	E 6,3	10	032 931 16	38	40 07157 31305 8
	3 x 1	PH 2 / PZ 2 / 5,5 x 0,8	50 mm	E 6,3	10	032 932 16	39	40 07157 52245 0



Felo Star automatic holder is a unique power tool accessory, providing decisive advantages to professionals.



Der Felo Star Automatikhalter ist ein einzigartiges Produkt mit echten Vorteilen für den Anwender in Industrie und Handwerk.

Making work safer, faster and more efficient !

felo star

Schraubarbeiten werden sicherer, schneller und wirtschaftlicher!



- **secure hold of screw**
- **automatic adjustment to depth of screw head**
- **genuine one-hand operation**
- **quick and easy replacement of bits**
- **compact size.**

- *sicherer Halt der Schraube*
- *automatische Einstellung auf die Tiefe des Schraubenkopfes*
- *echte Einhandbedienung*
- *einfaches und schnelles Wechseln des Bits*
- *kompakte Bauform.*



020



Item No
020 901 86



144

EAN-Code

40 07157 50855 3

AllStar Challenger Bit Box Universal C 6,3 x 25 mm

Felo Star + 10 Challenger Bits

(2 x) **020:** 1,0 x 5,5 / 1,2 x 6,5

(3 x) **021:** PZ 2

(1 x) **021:** PZ 3

(3 x) **022:** PH 2

(1 x) **022:** PH 3

(1 x) **038:** **Felo Star Automatic Holder** / Felo Star Automatikhalter

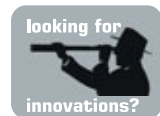

TiN
020



Item No
020 901 76



147

EAN-Code

40 07157 50787 7

AllStar TiN Bit Box Universal C 6,3 x 25 mm

Felo Star + 10 TiN Bits

(2 x) **020:** 1,0 x 5,5 / 1,2 x 6,5

(3 x) **021:** PZ 2

(1 x) **021:** PZ 3

(3 x) **022:** PH 2

(1 x) **022:** PH 3

(1 x) **038:** **Felo Star Automatic Holder** / Felo Star Automatikhalter

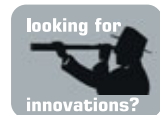

TiN
020



Item No
020 902 76



149

EAN-Code

40 07157 50789 1

AllStar TiN Bit Box Holz, C 6,3 x 25 mm

Felo Star + 10 TiN Bits

(4 x) **021:** PZ 2

(1 x) **021:** PZ 3

(2 x) **026:** Torx 20

(1 x) **026:** Torx 25

(1 x) **026:** Torx 30

(1 x) **026:** Torx 40

(1 x) **038:** **Felo Star Automatic Holder** / Felo Star Automatikhalter



TiN 026



		Item No		EAN-Code
AllStar TiN Bit Box Torx, C 6,3 x 25 mm	10	026 901 76	148	40 07157 50791 4
Felo Star + 10 TiN Bits				
(4 x) 026:		Torx 20		
(2 x) 026:		Torx 25		
(1 x) 026:		Torx 27		
(2 x) 026:		Torx 30		
(1 x) 026:		Torx 40		
(1 x) 038:		Felo Star Automatic Holder / Felo Star Automatikhalter		

020



		Item No		EAN-Code
AllStar Bit Box Universal, C 6,3 x 25 mm	10	020 901 16	146	40 07157 50793 8
Felo Star + 10 Bits				
(2 x) 020:		1,0 x 5,5 / 1,2 x 6,5		
(3 x) 021:		PZ 2		
(1 x) 021:		PZ 3		
(3 x) 022:		PH 2		
(1 x) 022:		PH 3		
(1 x) 038:		Felo Star Automatic Holder / Felo Star Automatikhalter		

020



		Item No		EAN-Code
AllStar Bit Box Holz , C 6,3 x 25 mm	10	020 902 16	147	40 07157 50795 2
Felo Star + 10 Bits				
(4 x) 021:		PZ 2		
(1 x) 021:		PZ 3		
(2 x) 026:		Torx 20		
(1 x) 026:		Torx 25		
(1 x) 026:		Torx 30		
(1 x) 026:		Torx 40		
(1 x) 038:		Felo Star Automatic Holder / Felo Star Automatikhalter		

026



		Item No		EAN-Code
AllStar Bit Box Torx , C 6,3 x 25 mm	10	026 901 16	148	40 07157 50797 6
Felo Star + 10 Bits				
(4 x) 026:		Torx 20		
(2 x) 026:		Torx 25		
(1 x) 026:		Torx 27		
(2 x) 026:		Torx 30		
(1 x) 026:		Torx 40		
(1 x) 038:		Felo Star Automatic Holder / Felo Star Automatikhalter		

TiN 020



		Item No		EAN-Code
AllStar C 6,3 x 25 mm	10	020 903 76	144	40 07157 50977 2
Felo Star + 10 TiN Bits				
(4 x) 021: PZ 2				
(1 x) 021: PZ 3				
(4 x) 022: PH 2				
(1 x) 022: PH 3				
(1 x) 038: Felo Star Automatic Holder / Felo Star Automatikhalter				

TiN 026

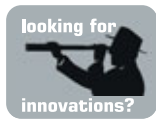

		Item No		EAN-Code
AllStar C 6,3 x 25 mm	10	020 904 76	149	40 07157 51011 2
Felo Star + 10 TiN Bits				
(2 x) 022: PH 2				
(2 x) 021: PZ 2				
(1 x) 021: PZ 3				
(2 x) 026: Torx 20				
(1 x) 026: Torx 25				
(1 x) 026: Torx 30				
(1 x) 026: Torx 40				
(1 x) 038: Felo Star Automatic Holder / Felo Star Automatikhalter				



felo
swift

- All sizes at one glance • easy selection of bits by pick and pull (one-hand operation) • auxiliary screwdriver function
- Bit-Größen auf einen Blick • einfaches Entnehmen (Einhandbedienung) • Funktion als Hilfsschraubendreher



020





			Item No		EAN-Code
TiN Universal Box Swift C 6,3 x 25 mm		10	020 601 76	72	40 07157 51383 0
6 TiN Bits + Bitholder / Magnethalter					
{ 2 x } 020:	1,0 x 5,5 / 1,2 x 6,5				
{ 2 x } 021:	PZ 1 / PZ 2				
{ 2 x } 022:	PH 1 / PH 2				
{ 1 x } 038:	Bitholder / Magnethalter				
dto. on card / auf Karte		10	020 601 71	84	40 07157 52725 7
PZ TiN Box Swift C 6,3 x 25 mm		10	020 602 76	72	40 07157 51385 4
6 TiN Bits + Bitholder / Magnethalter					
{ 2 x } 021:	PZ 1				
{ 3 x } 021:	PZ 2				
{ 1 x } 021:	PZ 3				
{ 1 x } 038:	Bitholder / Magnethalter				
dto. on card / auf Karte		10	020 602 71	84	40 07157 52727 1



020



		Item No		EAN-Code
PH - PZ TiN Box Swift C 6,3 x 25 mm	10	020 603 76	72	40 07157 51387 8

6 TiN Bits + Bitholder / Magnethalter



(3 x) **021:** PZ 1 / PZ 2 / PZ 3

(3 x) **022:** PH 1 / PH 2 / PH 3

(1 x) **038:** **Bitholder / Magnethalter**

dto. on card / auf Karte	10	020 603 71	84	40 07157 52729 5
---------------------------------	----	-------------------	----	------------------



Torx TiN Box Swift C 6,3 x 25 mm	10	020 604 76	73	40 07157 51389 2
---	----	-------------------	----	------------------

6 TiN Bits + Bitholder / Magnethalter

(6 x) **026:** Torx 10 / Torx 15 / Torx 20 /
Torx 25 / Torx 30 / Torx 40

(1 x) **038:** **Bitholder / Magnethalter**

dto. on card / auf Karte	10	020 604 71	84	40 07157 52731 8
---------------------------------	----	-------------------	----	------------------



Swift TiN Bit-Box C 6,3 x 25 mm	10	020 605 76	71	40 07157 51411 0
--	----	-------------------	----	------------------

6 TiN Bits + Bitholder / Magnethalter



(3 x) **021:** PZ 1 / PZ 2 / PZ 3

(3 x) **026:** Torx 15 / Torx 20 / Torx 25

(1 x) **038:** **Bitholder / Magnethalter**

dto. on card / auf Karte	10	020 605 71	84	40 07157 52733 2
---------------------------------	----	-------------------	----	------------------



PH 2 TiN Swift Bit-Box C 6,3 x 25 mm	10	020 608 76	72	40 07157 51971 9
---	----	-------------------	----	------------------

6 TiN Bits + Bitholder / Magnethalter

(6 x) **022:** PH 2

(1 x) **038:** **Bitholder / Magnethalter**

dto. on card / auf Karte	10	020 608 71	85	40 07157 52737 0
---------------------------------	----	-------------------	----	------------------



Diamant Swift Bit-Box C 6,3 x 25 mm	10	020 603 86	70	40 07157 51707 4
--	----	-------------------	----	------------------

6 Diamant Bits + Bitholder / Magnethalter



(3 x) **021:** PZ 1 / PZ 2 / PZ 3



(3 x) **022:** PH 1 / PH 2 / PH 3

(1 x) **038:** **Bitholder / Magnethalter**

dto. on card / auf Karte	10	020 603 81	82	40 07157 52735 6
---------------------------------	----	-------------------	----	------------------

026



Item No



EAN-Code

	Box Swift C 6,3 x 25 mm	10	020 601 16	72	40 07157 51391 5
	6 Bits + Bitholder / Magnethalter				
	(2 x) 020:	1,0 x 5,5 / 1,2 x 6,5			
	(2 x) 021:	PZ 1 / PZ 2			
	(2 x) 022:	PH 1 / PH 2			
	(1 x) 038:	Bitholder / Magnethalter			
	dto. on card / auf Karte	10	020 601 11	83	40 07157 52717 2
	PZ Box Swift C 6,3 x 25 mm	10	020 602 16	72	40 07157 51393 9
	6 Bits + Bitholder / Magnethalter				
	(2 x) 021:	PZ 1			
	(3 x) 021:	PZ 2			
	(1 x) 021:	PZ 3			
	(1 x) 038:	Bitholder / Magnethalter			
	dto. on card / auf Karte	10	020 602 11	84	40 07157 52719 6
	Torx Box Swift C 6,3 x 25 mm	10	020 603 16	73	40 07157 51395 3
	6 Bits + Bitholder / Magnethalter				
	(6 x) 026:	Torx 10 / Torx 15 / Torx 20 / Torx 25 / Torx 30 / Torx 40			
	(1 x) 038:	Bitholder / Magnethalter			
	dto. on card / auf Karte	10	020 603 11	85	40 07157 52721 9
	Torx TR Box Swift C 6,3 x 25 mm	10	020 610 16	73	40 07157 61669 2
	6 Bits + Bitholder / Magnethalter				
	(6 x) 027:	Torx TR 10 / Torx TR 15 / Torx TR 20 / Torx TR 25 / Torx TR 30 / Torx TR 40			
	(1 x) 038:	Bitholder / Magnethalter			
	dto. on card / auf Karte	10	020 610 11	85	40 07157 60917 5
	PZ/PH Swift Box C 6,3 x 25 mm	10	020 603 26	72	40 07157 51689 3
	6 Bits + Bitholder / Magnethalter				
	(3 x) 021:	PZ 1 / PZ 2 / PZ 3			
	(3 x) 022:	PH 1 / PH 2 / PH 3			
	(1 x) 038:	Bitholder / Magnethalter			
	dto. on card / auf Karte	10	020 603 21	84	40 07157 52723 3

see Page 177 /
siehe Seite 177



see Page 161 /
siehe Seite 161





020



Item No



EAN-Code

Bits 30 [28 x]	30-pce / 30-tlg Bits C6,3 x 25mm 3,0 x 0,5/ 4,5 x 0,6/ 5,5 x 0,8/ 6,5 x 1,2 2mm/ 3mm/ 4mm/ 5mm/ 6mm PH0/ PH1/ PH2/ PH3 PZ1 /PZ2/ PZ3 Torx 5/ Torx 6/ Torx 7/ Torx 8/ Torx 10/ Torx 15/ Torx 20/ Torx 25/ Torx 30/ Torx 40 Spanner6/ Spanner8	1	020 730 06	306	40 07157 61563 3
[1 x]	ERGONIC Stubby 1/4"				
[1 x]	Bitholder / Bithalter E6,3 x 58mm				
	StrongBox 135mm x 75mm x 37mm				



020



Item No



EAN-Code

Bits 38 [36 x]	38-pce / 38-tlg. Bits C6,3 x 25mm 4,5 x 0,6/ 6,5 x 1,2 2mm/ 3mm/ 4mm/ 5mm/ 6mm PH0/ 2 x PH1/ 4 x PH2/ 2 x PH3 2 x PZ1 /5 x PZ2/ 2 x PZ3 Torx 6/ Torx 7/ Torx 8/ Torx 10/ Torx 15/ Torx 20/ Torx 25/ Torx 30/ Torx 40 SQ1/ SQ2	1	020 738 06	346	40 07157 61565 7
[1 x]	Felo Star Automatic-Holder/ Felo Star Automatischer Bithalter				
[1 x]	Bitholder / Bithalter E6,3 x 58mm				
	StrongBox 135mm x 75mm x 37mm				





020



Item No



EAN-Code

	Item No		EAN-Code
Bits 35	35-pce/35-tlg.	1	020 735 16
(28 x)	Bits C6,3 x 25mm	322	40 07157 61567 1
	4,5 x 0,6/ 5,5 x 0,8/ 6,5 x 1,2		
	3mm/ 4mm/ 5mm		
	PH0/ 2 x PH1/ 2 x PH2/ PH3		
	2 x PZ1 /3 x PZ2/ PZ3		
	Torx 5/ Torx 6/ Torx 7/ Torx 8/ Torx 10/ Torx 15/ Torx 20/ Torx 25/ Torx 30/ Torx 40		
(6 x)	Bits E6,3 x 50mm		
	PZ1/ PZ2		
	PH2		
	Torx 20/ Torx 25/ Torx 30		
(1 x)	Bitholder / Bithalter E6,3 x 58mm		
	StrongBox 135mm x 75mm x 37mm		



TiN 020



Item No



EAN-Code

Profi Bit Box, 12TiN Bits + Bitholder C 6,3 x 25 mm	10	020 917 16	107	40 07157 31445 1
(4 x) 020:	0,8 x 5,0 / 1,0 x 5,5 / 1,2 x 6,5 / 1,2 x 8,0			
(2 x) 021:	PZ 1 / PZ 3			
(2 x) 021:	PZ 2			
(2 x) 022:	PH 1 / PH 3			
(2 x) 022:	PH 2			
(1 x) 038:	Bitholder / Magnethalter 58 mm			



TiN 021



Item No



EAN-Code

Profi Bit Box, 12TiN Bits + Bitholder C 6,3 x 25 mm	10	021 910 76	104	40 07157 31537 3
(2 x) 021:	PZ 1			
(8 x) 021:	PZ 2			
(2 x) 021:	PZ 3			
(1 x) 038:	Bitholder / Magnethalter 58 mm			



TiN 022



Item No



EAN-Code

Profi Bit Box, 12TiN Bits + Bitholder C 6,3 x 25 mm	10	022 910 76	104	40 07157 31408 6
(2 x) 021:	PZ 1			
(3 x) 021:	PZ 2			
(1 x) 021:	PZ 3			
(2 x) 022:	PH 1			
(3 x) 022:	PH 2			
(1 x) 022:	PH 3			
(1 x) 038:	Bitholder / Magnethalter 58 mm			



TiN 032



Profi Bit Box, 6 TiN Bits E 6,3 x 50 mm
 [3 x] **031:** PZ 1 / PZ 2 / PZ 3
 [3 x] **032:** PH 1 / PH 2 / PH 3



10

Item No

032 915 76



79

EAN-Code

40 07157 31413 0

TiN 036



Profi Bit Box, 6 TiN Bits E 6,3 x 50 mm
 [6 x] **036:** Torx 10 / Torx 15 / Torx 20
 Torx 25 / Torx 30 / Torx 40



10

Item No

036 915 76



75

EAN-Code

40 07157 32384 2

see Page 161 /
 siehe Seite 161



020



Item No



EAN-Code

Profi Bit Box, 12 Bits + Bitholder C 6,3 x 25 mm	10	020 910 16	107	40 07157 31405 5
(4 x) 020:	0,8 x 5,0 / 1,0 x 5,5 / 1,2 x 6,5 / 1,2 x 8,0			
(2 x) 021:	PZ 1 / PZ 3			
(2 x) 021:	PZ 2			
(2 x) 022:	PH 1 / PH 3			
(2 x) 022:	PH 2			
(1 x) 038:	Bitholder / Magnethalter 58 mm			



022



Item No



EAN-Code

Profi Bit Box, 12 Bits + Bitholder C 6,3 x 25 mm	10	022 910 16	104	40 07157 31407 9
(2 x) 021:	PZ 1			
(3 x) 021:	PZ 2			
(1 x) 021:	PZ 3			
(2 x) 022:	PH 1			
(3 x) 022:	PH 2			
(1 x) 022:	PH 3			
(1 x) 038:	Bitholder / Magnethalter 58 mm			



026



Item No





EAN-Code

Profi Bit Box, 12 Bits + Bitholder C 6,3 x 25 mm	10	026 910 16	104	40 07157 31409 3
(10 x) 026:	Torx 06 / Torx 07 / Torx 08 / Torx 09 Torx 10 / Torx 15 / Torx 20 / Torx 27 Torx 30 / Torx 40			
(2 x) 026:	Torx 25			
(1 x) 038:	Bitholder / Magnethalter 58 mm			



030

		Item No		EAN-Code
Profi Bit Box, 6 Bits E 6,3 x 50 mm	10	030 915 16	78	40 07157 31410 9
[6 x] 030:		0,6 x 3,5 / 0,8 x 4,0 / 0,8 x 5,0		
		1,0 x 5,5 / 1,2 x 6,5 / 1,2 x 8,0		

032

		Item No		EAN-Code
Profi Bit Box, 6 Bits E6,3 x50mm	10	032 915 16	78	40 07157 31412 3
[3 x] 031:		PZ 1 / PZ 2 / PZ 3		
[3 x] 032:		PH 1 / PH 2 / PH 3		

036

		Item No		EAN-Code
Profi Bit Box, 6 Bits E 6,3 x 50 mm	10	036 915 16	75	40 07157 31419 2
[6 x] 036:		Torx 10 / Torx 15 / Torx 20		
		Torx 25 / Torx 30 / Torx 40		

030



Item No



EAN-Code

Profi Bit Box, 5 Bits E 6,3 x 73 mm

10

030 917 16

83

40 07157 31411 6

[5 x] **030:** 0,5 x 3,0 / 0,6 x 3,5 / 0,8 x 4,0

1,0 x 5,5 / 1,2 x 6,5

032



Item No



EAN-Code

Profi Bit Box, 6 Bits E 6,3 x 73 mm

10

032 917 16

112

40 07157 31385 0

[3 x] **031:** PZ 1 / PZ 2 / PZ 3

[3 x] **032:** PH 1 / PH 2 / PH 3

036



Item No



EAN-Code

Profi Bit Box, 6 Bits E 6,3 x 73 mm

10

036 917 16

100

40 07157 31417 8

[6 x] **036:** Torx 10 / Torx 15 / Torx 20

Torx 25 / Torx 30 / Torx 40

020



Item No



EAN-Code

Schraub-Box, 9 Bits + Bitholder C 6,3 x 25 mm	6	020 995 06	110	40 07157 30158 1
(3 x) 020:	0,8 x 5,0 / 1,0 x 5,5 / 1,2 x 7,0			
(3 x) 021:	PZ 1 / PZ 2 / PZ 3			
(3 x) 022:	PH 1 / PH 2 / PH 3			
(1 x) 038:	Bitholder / Magnethalter 58 mm			



Torx-Box, 9 Bits + Bitholder C 6,3 x 25 mm	6	023 995 60	110	40 07157 22197 1
(9 x) 026:	Torx 08 / Torx 09 / Torx 10 / Torx 15			
	Torx 20 / Torx 25 / Torx 27 / Torx 30			
	Torx 40			
(1 x) 038:	Bitholder / Magnethalter 58 mm			



Item No



EAN-Code

TiN-Box, 9 TiN Bits + Bitholder C 6,3 x 25 mm	6	020 997 06	110	40 07157 22196 4
(3 x) 020:	0,8 x 4,0 / 1,0 x 5,5 / 1,2 x 6,5			
(3 x) 021:	PZ 1 / PZ 2 / PZ 3			
(3 x) 022:	PH 1 / PH 2 / PH 3			
(1 x) 038:	Bitholder / Magnethalter 58 mm			



TiN 020

057



Item No



EAN-Code

1/4" Nuss-Box, 8 Steckschlüssel + Adapter

6

057 981 06

172

40 07157 22198 8

(8 x) 4 mm / 5 mm / 5,5 mm / 6 mm / 7 mm

8 mm / 10 mm / 13 mm

(1 x) **097:** **Adapter** (Art.No. 097 013 10)



TiN
020



Item No



EAN-Code

TiN Bit Box, 25 TiN Bits + Bitholder C 6,3 x 25 mm

6

020 026 76

194

40 07157 50811 9

(5 x) **026:** Torx 10 / Torx 15 / Torx 27 / Torx 30 / Torx 40

(2 x 3) Torx 20 / Torx 25

(2 x 3) **021:** PZ 1 / PZ 3

(8 x) PZ 2

(1 x) **038:** **Bitholder** / *Magnethalter 58 mm*



020



Item No



EAN-Code

Bit Box, 25 Bits + Bitholder C 6,3 x 25 mm

6

020 026 16

196

40 07157 50801 0

(10 x) **026:** Torx 06 / Torx 08 / Torx 09 / Torx 10

Torx 15 / Torx 20 / Torx 25 / Torx 27

Torx 30 / Torx 40

(3 x) **021:** PZ1 / PZ2 / PZ3

(3 x) **022:** PH1 / PH2 / PH3

(3 x) **020:** 0,8 x 4,0 / 1,0 x 5,5 / 1,2 x 6,5

(6 x) **024:** SW 2,0 / SW 2,5 / SW 3,0 / SW 4,0



SW 5,0 / SW 6,0

(1 x) **038:** **Bitholder** / *Magnethalter 58 mm*





026



			Item No		EAN-Code
	Torx-Box, 25 Bits + Bitholder C 6,3 x 25 mm	6	026 026 16	195	40 07157 50803 4
(4 x)	026: Torx 05 / Torx 08 / Torx 09 / Torx 27				
(2 x 2)	Torx 06 / Torx 10				
(3 x 3)	Torx 15 / Torx 30 / Torx 40				
(2 x 4)	Torx 20 / Torx 25				
(1 x)	038: Bitholder / <i>Magnethalter 58 mm</i>				

020



			Item No		EAN-Code
	Bit Box Holz, 25 Bits + Bitholder C 6,3 x 25 mm	6	020 126 16	195	40 07157 50805 8
(5 x)	026: Torx 10 / Torx 15 / Torx 27				
	Torx 30 / Torx 40				
(2 x 3)	Torx 20 / Torx 25				
(2 x 3)	021: PZ 1 / PZ 3				
(8 x)	PZ 2				
(1 x)	038: Bitholder / <i>Magnethalter 58 mm</i>				

021



Item No



EAN-Code

Bit Box PZ, 25 Bits + Bitholder C 6,3 x 25 mm 6 **021 026 16** 194 40 07157 50807 2

(2 x) **021:** PZ 0

(8 x) PZ 1

(12 x) PZ 2

(3 x) PZ 3

(1 x) **038:** **Bitholder / Magnethalter 58 mm**



Bit Box PH-PZ, 25 Bits + Bitholder C 6,3 x 25 mm 6 **020 226 16** 191 40 07157 50809 6

(2 x) **021:** PZ 0

(3 x) PZ 1

(5 x) PZ 2

(2 x) PZ 3

(2 x) **022:** PH 0

(4 x) PH 1

(5 x) PH 2

(2 x) PH 3

(1 x) **038:** **Bitholder / Magnethalter 58 mm**

020



Item No



EAN-Code

Security Bit Box + Bitholder 6 **020 326 16** 196 40 07157 51565 0

(2 x) **024:** SW 4,0 / 3,0

(3 x) **028:** XZN M6 / XZN M5 / XZN M4

(5 x) **029:** TS 10 / TS 8 / TS 6 / TS 4 / TS 0

(5 x) **027:** TxTR 30 / TxTR 25 / TxTR 20 / TxTR 15 / TxTR 10

(5 x) **029:** Tri-Wing 5 / 4 / 3 / 2 / 1

(3 x) **020:** Spanner 6 / 8 / 10

(2 x) **028:** Clutch 5/32, 1/4

(1 x) **038:** **Bitholder / Magnethalter 58 mm**



020



Item No



EAN-Code

Bit-Box, 6 Bits + Bitholder C 6,3 x 25 mm	10	020 974 60	95	40 07157 30141 3
(2 x) 020: 0,8 x 5,0 / 1,2 x 7,0				
(2 x) 021: PZ 1 / PZ 2				
(2 x) 022: PH 1 / PH 2				
(1 x) 038: Bitholder / <i>Magnethalter 58 mm</i>				
dto. boxed / im Karton	10	020 974 61	104	40 07157 30142 0
Bit-Box, 8 Bits + Bitholder C 6,3 x 25 mm	10	020 994 60	111	40 07157 30156 7
(4 x) 020: 0,8 x 4,0 / 1,0 x 5,5 / 1,2 x 6,5 1,6 x 8,0				
(2 x) 021: PZ1 / PZ 2				
(2 x) 022: PH1 / PH 2				
(1 x) 038: Bitholder / <i>Magnethalter 58 mm</i>				
dto. boxed / im Karton	10	020 994 61	120	40 07157 30157 4
Torx-Box, 6 Bits + Bitholder C 6,3 x 25 mm	10	023 974 60	95	40 07157 30251 9
(6 x) 026: Torx 10 / Torx 15 / Torx 20 Torx 25 / Torx 30 / Torx 40				
(1 x) 038: Bitholder / <i>Magnethalter 58 mm</i>				
dto. on card / auf Karte	10	023 974 61	104	40 07157 30252 6
Torx Tamper Resistant Box C 6,3 x 25 mm	10	027 974 60	95	40 07157 31577 9
6 Bits + Bitholder				
(6 x) 027: TorxTR 10 / TorxTR 15 / TorxTR 20 TorxTR 25 / TorxTR 30 / TorxTR 40				
(1 x) 038: Bitholder / <i>Magnethalter 58 mm</i>				

Special Bits & Adapters

**029
C 6,3**

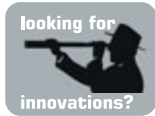

LocTec®					Item No		EAN-Code
3	25	C 6,3	1/4"	10	029 300 10	5	40 07157 60379 1
4	25	C 6,3	1/4"	10	029 400 10	5	40 07157 60381 4
5	25	C 6,3	1/4"	10	029 500 10	6	40 07157 60383 8
6	25	C 6,3	1/4"	10	029 600 10	6	40 07157 60385 2

**079
C 8**



LocTec®					Item No		EAN-Code
8	30	C 8	5/16"	10	079 080 10	11	40 07157 60389 0
10	30	C 8	5/16"	10	079 100 10	11	40 07157 60387 6

Screw in
Einschrauben

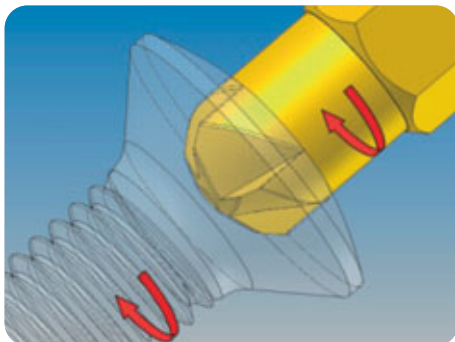

Simply screw in the LocTec® screw with the locking bit. No other locking measures are required.

Die LocTec® Schraube wird einfach mit dem Sicherungsbit verschraubt. Weitere Sicherungsmaßnahmen sind nicht notwendig.

Attempt to loosen the screw
Löseversuch

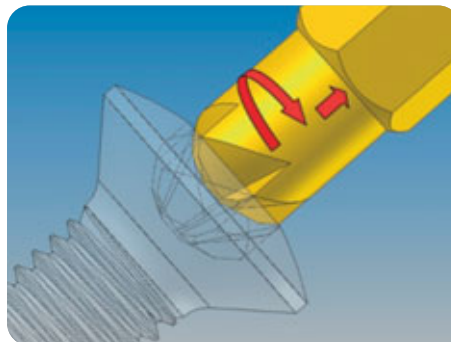

The special flank geometry ensures that any attempt to loosen the screw – even with the locking bit – will fail, since it will merely drive the fitting tool out.

Die spezielle Flankengeometrie sorgt dafür, dass jeglicher Lösungsversuch, auch unter Verwendung des Sicherungsbits, mit dem Herausdrehen des Montagewerkzeuges endet.

For more information visit /

Mehr Information unter:

www.arnold-umformtechnik.de

039 E 6,3



mm		E 6,3			Item No		EAN-Code
5	66 mm	E 6,3	1/4"	5	039 050 10	28	40 07157 50404 3
6	66 mm	E 6,3	1/4"	5	039 060 10	27	40 07157 50406 7
7	66 mm	E 6,3	1/4"	5	039 070 10	26	40 07157 51373 1
8	66 mm	E 6,3	1/4"	5	039 080 10	31	40 07157 50408 1
10	66 mm	E 6,3	1/4"	5	039 100 10	36	40 07157 50410 4
12	66 mm	E 6,3	1/4"	5	039 120 10	39	40 07157 53249 7
13	66 mm	E 6,3	1/4"	5	039 130 10	54	40 07157 50412 8

039 E 6,3



		E 6,3			Item No		EAN-Code
5/16"	66 mm	E 6,3	1/4"	5	039 516 10	31	40 07157 50414 2
3/8"	66 mm	E 6,3	1/4"	5	039 038 10	36	40 07157 50416 6

Special Bits for direct fit

Spezial Bits für direkten Maschinenanschluss

A5,5
AEG
BOSCH
HOLZ-HER
KRESS
METABO

G7
BAIER
FEIN

C8
BOSCH
FEIN
HOLZ-HER
LECUREUX
METABO

M5
BÖLLHOFF/
UNIQUE
HOLZ-HER
WEBER

10/32" NFA
USM
DUOFAST
DVSG

010 A 5,5



						Item No		EAN-Code
0,6 x 3,5	50 mm	A 5,5	5,5 mm	10		010 315 10	7	40 07157 30000 3
0,8 x 4,0	50 mm	A 5,5	5,5 mm	10		010 415 10	8	40 07157 30002 7
0,8 x 5,0	50 mm	A 5,5	5,5 mm	10		010 505 10	9	40 07157 30004 1
0,8 x 5,5	50 mm	A 5,5	5,5 mm	10		010 515 10	10	40 07157 30006 5
1,0 x 5,5	50 mm	A 5,5	5,5 mm	10		010 525 10	10	40 07157 30008 9
1,0 x 6,0	50 mm	A 5,5	5,5 mm	10		010 605 10	11	40 07157 30010 2
1,2 x 6,5	50 mm	A 5,5	5,5 mm	10		010 615 10	11	40 07157 30012 6
1,2 x 8,0	50 mm	A 5,5	5,5 mm	10		010 805 10	14	40 07157 30014 0

011 A 5,5



PZ						Item No		EAN-Code
1	50 mm	A 5,5	5,5 mm	10		011 015 10	8	40 07157 30019 5
2	50 mm	A 5,5	5,5 mm	10		011 025 10	10	40 07157 30021 8
3	50 mm	A 5,5	5,5 mm	10		011 035 10	12	40 07157 30023 2

012 A 5,5



PH						Item No		EAN-Code
1	50 mm	A 5,5	5,5 mm	10		012 015 10	8	40 07157 30025 6
2	50 mm	A 5,5	5,5 mm	10		012 025 10	10	40 07157 30027 0
3	50 mm	A 5,5	5,5 mm	10		012 035 10	13	40 07157 30029 4

014 A 5,5



mm						Item No		EAN-Code
2,5	50 mm	A 5,5	5,5 mm	10		014 255 10	7	40 07157 30031 7
3,0	50 mm	A 5,5	5,5 mm	10		014 305 10	8	40 07157 30033 1
4,0	50 mm	A 5,5	5,5 mm	10		014 405 10	9	40 07157 30035 5
5,0	50 mm	A 5,5	5,5 mm	10		014 505 10	11	40 07157 30037 9
6,0	50 mm	A 5,5	5,5 mm	10		014 605 10	12	40 07157 30039 3

040 G 7



						Item No		EAN-Code
0,6 x 3,5	53 mm	G 7		7 mm	10	040 315 10	9	40 07157 30344 8
0,8 x 4,0	53 mm	G 7		7 mm	10	040 415 10	9	40 07157 30346 2
0,8 x 5,0	53 mm	G 7		7 mm	10	040 505 10	10	40 07157 30348 6
0,8 x 5,5	53 mm	G 7		7 mm	10	040 515 10	11	40 07157 30350 9
1,0 x 5,5	53 mm	G 7		7 mm	10	040 525 10	11	40 07157 30352 3
1,0 x 6,0	53 mm	G 7		7 mm	10	040 605 10	12	40 07157 30354 7
1,2 x 6,5	53 mm	G 7		7 mm	10	040 615 10	13	40 07157 30356 1
1,2 x 8,0	53 mm	G 7		7 mm	10	040 805 10	15	40 07157 30358 5

041 G 7



				Item No		EAN-Code
1	53 mm	G 7	7 mm	041 015 10	10	40 07157 30363 9
2	53 mm	G 7	7 mm	041 025 10	12	40 07157 30365 3
3	53 mm	G 7	7 mm	041 035 10	13	40 07157 30367 7

042 G 7



				Item No		EAN-Code
1	53 mm	G 7	7 mm	042 015 10	10	40 07157 30369 1
2	53 mm	G 7	7 mm	042 025 10	11	40 07157 30371 4
3	53 mm	G 7	7 mm	042 035 10	15	40 07157 30373 8

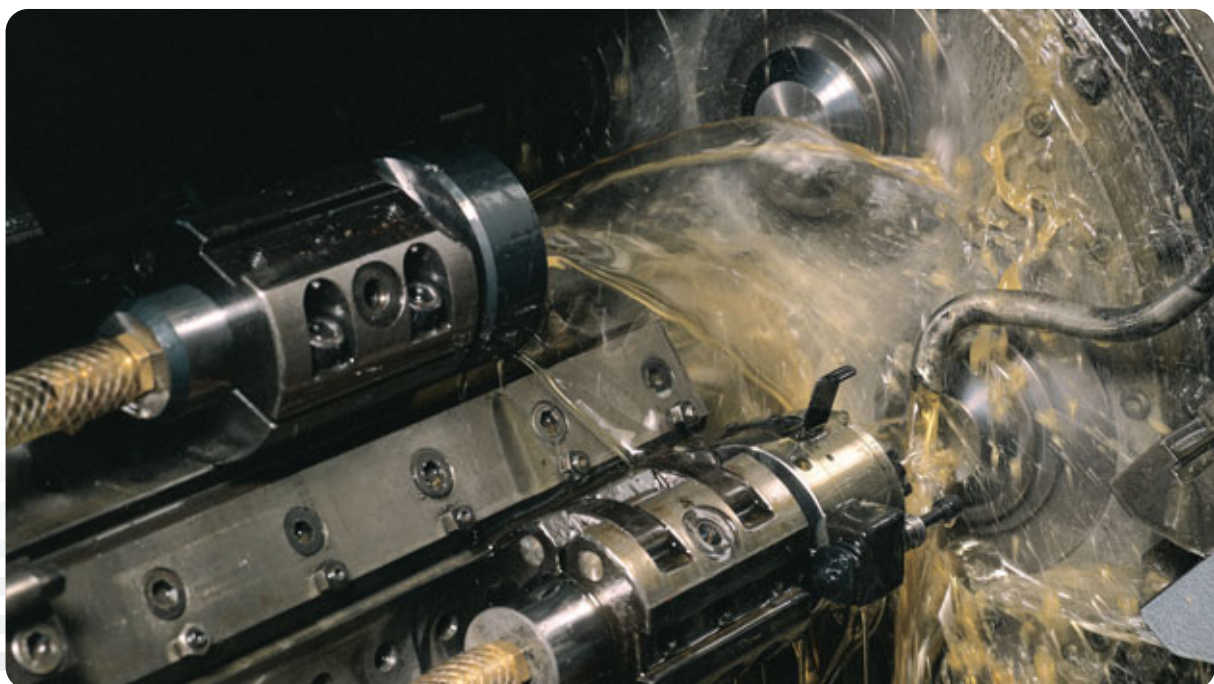

050 4mm



				Item No		EAN-Code
PZ 0 - PZ 1	28 mm	C 4 4 mm	1	051 001 10	2	40 07157 32334 7
PH 2 - 0,8 x 4,0	28 mm	C 4 4 mm	1	052 024 10	4	40 07157 32332 3
PH 1 - 0,5 x 3,0	28 mm	C 4 4 mm	1	052 130 10	3	40 07157 32344 6
1,5 mm - 2,0 mm	28 mm	C 4 4 mm	1	054 152 10	2	40 07157 32340 8
2,5 mm - 3,0 mm	28 mm	C 4 4 mm	1	054 253 10	3	40 07157 32342 2
4,0 mm - Torx 8	28 mm	C 4 4 mm	1	056 084 10	2	40 07157 32338 5
Torx 10 - Torx 15	28 mm	C 4 4 mm	1	056 115 10	2	40 07157 32336 1
Torx 5 - 0,4 x 2,5	28 mm	C 4 4 mm	1	056 825 10	2	40 07157 32346 0

060 6,3mm



				Item No		EAN-Code
0,8 x 4,0/						
0,8 x 5,0	60 mm	1/4"	10	060 456 10	12	40 07157 30421 6
1,0 x 5,5/						
1,2 x 6,5	60 mm	1/4"	10	060 566 10	13	40 07157 30423 0
1,2 x 8,0						
1,6 x 9,0	60 mm	1/4"	10	060 896 10	21	40 07157 30425 4

061 6,3mm



				Item No		EAN-Code
PZ						
1/2	60 mm	1/4"	10	061 126 10	13	40 07157 30429 2
2/2	60 mm	1/4"	10	061 226 10	13	40 07157 50522 4
2/3	60 mm	1/4"	10	061 236 10	14	40 07157 30431 5

062 6,3mm



				Item No		EAN-Code
PH						
1/2	60 mm	1/4"	10	062 126 10	12	40 07157 30433 9
2/3	60 mm	1/4"	10	062 236 10	13	40 07157 30435 3

070 C 8



						Item No		EAN-Code
0,8 x 5,5	32 mm	C 8	5/16"	10	070 514 10	8	40 07157 30988 4	
1,0 x 5,5	32 mm	C 8	5/16"	10	070 524 10	8	40 07157 30989 1	
1,0 x 6,0	32 mm	C 8	5/16"	10	070 604 10	9	40 07157 30990 7	
1,2 x 6,5	32 mm	C 8	5/16"	10	070 614 10	9	40 07157 30991 4	
1,2 x 8,0	32 mm	C 8	5/16"	10	070 804 10	11	40 07157 30992 1	
1,6 x 8,0	32 mm	C 8	5/16"	10	070 814 10	11	40 07157 30993 8	
1,6 x 10,0	38 mm	C 8	5/16"	10	070 104 10	17	40 07157 30986 0	
2,0 x 12,0	38 mm	C 8	5/16"	10	070 204 10	21	40 07157 30987 7	

071 C 8



PZ



					Item No		EAN-Code
1	32 mm	C 8	5/16"	10	071 010 10	9	40 07157 30994 5
2	32 mm	C 8	5/16"	10	071 020 10	10	40 07157 30995 2
3	32 mm	C 8	5/16"	10	071 030 10	11	40 07157 30996 9
4	38 mm	C 8	5/16"	10	071 042 10	17	40 07157 30997 6

»felo is your specialist with great experience in custom made items and solutions of the highest quality.

»felo ist Ihr erfahrener Spezialist für Sonderanfertigungen und Problemlösungen in höchster Qualität.



072 C 8



PH					Item No		EAN-Code
1	32 mm	C 8	5/16"	10	072 010 10	9	40 07157 30998 3
2	32 mm	C 8	5/16"	10	072 020 10	10	40 07157 30999 0
3	32 mm	C 8	5/16"	10	072 030 10	10	40 07157 31000 2
4	38 mm	C 8	5/16"	10	072 042 10	16	40 07157 31001 9

074 C 8



mm					Item No		EAN-Code
3	32 mm	C 8	5/16"	10	074 300 10	10	40 07157 31003 3
4	32 mm	C 8	5/16"	10	074 400 10	10	40 07157 31004 0
5	32 mm	C 8	5/16"	10	074 500 10	11	40 07157 31005 7
6	32 mm	C 8	5/16"	10	074 600 10	12	40 07157 31006 4
8	32 mm	C 8	5/16"	10	074 800 10	13	40 07157 31007 1
10	32 mm	C 8	5/16"	10	074 100 10	20	40 07157 31002 6

076 C 8



Torx					Item No		EAN-Code
25	32 mm	C 8	5/16"	10	076 253 10	10	40 07157 31008 8
27	32 mm	C 8	5/16"	10	076 273 10	10	40 07157 31009 5
30	32 mm	C 8	5/16"	10	076 303 10	11	40 07157 31010 1
40	32 mm	C 8	5/16"	10	076 403 10	11	40 07157 31011 8
45	32 mm	C 8	5/16"	10	076 453 10	12	40 07157 31012 5
50	32 mm	C 8	5/16"	10	076 503 10	13	40 07157 31013 2
55	32 mm	C 8	5/16"	10	076 553 10	18	40 07157 31014 9



078 C 8



XZN	Length	Flute	Tip	Box	Item No	Unit	EAN-Code
M 5	35 mm	C 8	5/16"	10	078 050 10	11	40 07157 50384 8
M 6	35 mm	C 8	5/16"	10	078 060 10	12	40 07157 50386 2
M 8	35 mm	C 8	5/16"	10	078 080 10	13	40 07157 50388 6
M10	35 mm	C 8	5/16"	10	078 100 10	17	40 07157 50390 9
M12	35 mm	C 8	5/16"	10	078 120 10	22	40 07157 50392 3

078 C 8



XZN	Length	Flute	Tip	Box	Item No	Unit	EAN-Code
M 5	120 mm	C 8	5/16"	10	078 005 10	27	40 07157 50394 7
M 6	120 mm	C 8	5/16"	10	078 006 10	48	40 07157 50396 1
M 8	120 mm	C 8	5/16"	10	078 008 10	45	40 07157 50398 5
M 10	120 mm	C 8	5/16"	10	078 010 10	71	40 07157 50400 5
M 12	120 mm	C 8	5/16"	10	078 012 10	95	40 07157 50402 9

081

Gewinde/
Thread

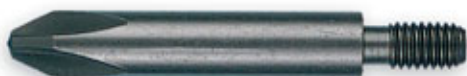

PZ	Length	Flute	Tip	Box	Item No	Unit	EAN-Code
2	44,5 mm	M 5	6 mm	10	081 020 10	9	40 07157 31354 8
2	44,5 mm	10/32" NFA	6 mm	10	081 025 10	8	40 07157 31355 3

082

Gewinde/
Thread



PH	Length	Flute	Tip	Box	Item No	Unit	EAN-Code
2	44,5 mm	M 5	6 mm	10	082 020 10	8	40 07157 31356 0
2	44,5 mm	10/32" NFA	6 mm	10	082 025 10	8	40 07157 31357 7

086

Gewinde/
Thread



Torx	Length	Flute	Tip	Box	Item No	Unit	EAN-Code
20	44,5 mm	M 5	6 mm	10	086 200 10	9	40 07157 31358 4
25	44,5 mm	M 5	6 mm	10	086 250 10	10	40 07157 31359 1

Bitholder & Adapters

429

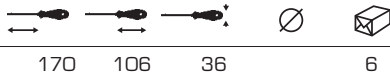

1/4" 170 106 36 6



Item No
429 635 40

146

EAN-Code
40 07157 60365 4



438

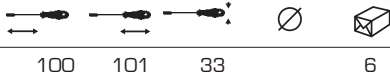

1/4" 100 101 33 6



Item No
438 125 40

102

EAN-Code
40 07157 53711 9

338



1/4" 125 100 6



Item No
338 125 80

111

EAN-Code
40 07157 32350 7

518



1/4" 105 99 34 6



AC 1000V
IEC 60900 : 2004



Item No
518 125 90

107

EAN-Code
40 07157 50785 3

538



Star-	100	99	34	6	Item No	102	EAN-Code
Automatikhalter 1/4"					538 100 40		40 07157 51397 7

038



FeloStar	70 mm	E 6,3	1/4"	6	Item No	31	EAN-Code
FeloStar					038 165 90		40 07157 50799 0

dto on card / auf Karte

	70 mm	E 6,3	1/4"	6	038 165 94	37	40 07157 52673 1
FeloStar	150 mm	E 6,3	1/4"	6	038 169 90	55	40 07157 51979 5
FeloStar	450 mm	E 6,3	1/4"	4	038 170 90	128	40 07157 60367 8



538



1/4"	100	99	34	6	Item No	102	EAN-Code
1/4"					538 125 40		40 07157 32348 4

038



Bitholder extra strong / Magnethalter extra stark	47 mm	E 6,3	1/4"	6	Item No	17	EAN-Code
Bitholder / Magnethalter					038 109 90		40 07157 30850 4

	58 mm	E 6,3	1/4"	6	038 103 90	22	40 07157 30340 0
--	-------	-------	------	---	-------------------	----	------------------

dto. in PP-Box				6	038 103 96	30	40 07157 10288 1
-----------------------	--	--	--	---	-------------------	----	------------------

Bitholder with retaining ring / Magnethalter mit Sprengring	74 mm	E 6,3	1/4"	6	038 102 90	30	40 07157 30337 0
--	-------	-------	------	---	-------------------	----	------------------

Bitholder with retaining ring / Magnethalter mit Sprengring	100 mm	E 6,3	1/4"	6	038 105 90	31	40 07157 50458 6
--	--------	-------	------	---	-------------------	----	------------------

Bitholder with retaining ring / Magnethalter mit Sprengring	150 mm	E 6,3	1/4"	6	038 107 90	44	40 07157 50464 7
--	--------	-------	------	---	-------------------	----	------------------

018



Bitholder / Magnethalter

72 mm A 5,5 1/4" 6

Item No

018 102 90



30

EAN-Code

40 07157 30043 0

037

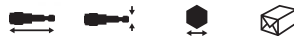

Mech. Bithalter

51 mm E 6,3 1/4" 6

Item No

037 103 90



25

EAN-Code

40 07157 32146 6

048

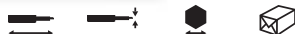

Bitholder / Magnethalter

72 mm G 7 1/4" 6

Item No

048 102 90



31

EAN-Code

40 07157 30381 3

Bitholder with retaining ring / Magnethalter mit Sprengring

74 mm G 7 1/4" 6

048 102 80



31

40 07157 32452 8

058

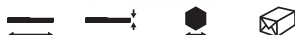

Bitholder / Magnethalter

98 mm SDS 1/4" 6

Item No

058 102 90



58

EAN-Code

40 07157 30978 5

059

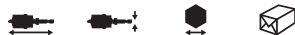

Indenter Bit Holder / Tiefenanschlag-Bithalter

max. 79 mm E 6,3 1/4" 6

Item No

059 103 90



74

EAN-Code

40 07157 51897 2

incl. Bit PH 2 x 25

097

1/4" ■



Adapter	50 mm	A 5,5	1/4"	6
----------------	-------	-------	------	---

Item No

097 011 10



15

EAN-Code

40 07157 30479 7

097

1/4" ■



Adapter	50 mm	E 6,3	1/4"	6
	150 mm	E 6,3	1/4"	6

Item No

097 013 10



15

EAN-Code

40 07157 30481 0

40 07157 32128 2

097

1/4" ■



Extension / Verlängerung	75 mm	E 6,3	1/4"	6
---------------------------------	-------	-------	------	---

Item No

097 070 10



45

EAN-Code

40 07157 52423 2

097

1/4" ■



Adapter	25 mm	1/4"	C 6,3	6
----------------	-------	------	-------	---

Item No

097 018 10



14

EAN-Code

40 07157 30851 1

097

1/4" ■



Adapter	50 mm	E 6,3	3/8"	6
----------------	-------	-------	------	---

Item No

097 020 10



23

EAN-Code

40 07157 30489 6

**finely-serrated jaws
providing firm grip**

*Geräumte Greifflächen für
sicheren Halt am Werkstück*

**induction-hardened cut-
ting edge, 60 / 64 HRC**

*Schneide zusätzlich induktiv
gehärtet, 60 / 64 HRC*

precise joint for optimum leverage

Spießfreies und leichtgängiges Gelenk



**optimum long-lasting
corrosion protection
from special matte
chromium surface**

*optimaler dauerhafter
Oberflächenschutz
durch speziellen
Matt-Chrom*

**Outstanding cutting
performance and
highest precision**

*Optimale Schneidleistung
bei maximaler Präzision*

**Professional quality
for heavy duty use**

Pliers / Zangen

*Profiqualität für
härtesten Einsatz*

Slip-stop wings for secure grip

Abgleitschutz für sicheren Griff

**ergonomically refined design
for maximum comfort**

*ergonomisch ausgereiftes
Design für höchsten
Arbeitskomfort*

**Red/yellow model indivi-
dually tested up to
1000V, VDE IEC 60900**

*Einzelstückprüfung in der
rot/gelben Ausführung
1000V, VDE IEC 60900*

**superior hardness
which exceeds DIN
and ISO requirements
by up to 100%**

*Beste Leistungsdaten,
bis zu 100% über
DIN-Werten*

**Quality of Workmanship
and materials guaranteed**

*Garantie auf Verarbeitung
und Material*

**drop-forged
from special steel**

*gesenkgeschmiedet aus
Spezialstahl*

**2-component
handle technology**

*2Komponenten
Grifftechnologie*



GS tested for safety

GS - geprüfte Sicherheit



**EAN code
on every product**

*EAN-Code auf
jedem Werkzeug*

590



		Item No		EAN-Code
160 mm Combination Pliers / Kombizange	6	590 016 10	194	40 07157 50020 5
180 mm Combination Pliers / Kombizange	6	590 018 10	247	40 07157 50022 9

591



		Item No		EAN-Code
145 mm Diagonal Nippers / Seitenschneider	6	591 014 10	182	40 07157 50024 3
160 mm Diagonal Nippers / Seitenschneider	6	591 016 10	225	40 07157 50026 7
180 mm Diagonal Nippers / Seitenschneider	6	591 018 10	300	40 07157 50028 1

591



		Item No		EAN-Code
180 mm Heavy-duty Diagonal Nippers <i>Kraftseitenschneider</i>	6	591 118 10	270	40 07157 50030 4

592



		Item No		EAN-Code
160 mm Chain Nose Radio Pliers / Telefonzange	6	592 016 10	159	40 07157 50034 2
200 mm Chain Nose Radio Pliers / Telefonzange	6	592 020 10	201	40 07157 50036 6

592



Item No



EAN-Code

200 mm Chain Nose Radio Pliers Angled 45°

6

592 220 10

212

40 07157 50038 0

Telefonzange 45° gebogen

593



Item No



EAN-Code

160 mm Insulation Stripping Pliers

6

593 016 10

175

40 07157 50040 3

Abisolierzange

894



Item No



EAN-Code

160 mm Pincers / Kneifzange

6

894 016 20

242

40 07157 50042 7

200 mm Pincers / Kneifzange

6

894 020 20

342

40 07157 50044 1

895



Item No



EAN-Code

250 mm Waterpump Pliers

6

895 025 20

260

40 07157 50064 9

Wasserpumpenzange

580



AC 1000V
IEC 60900 : 2004

		Item No		EAN-Code
160 mm Combination Pliers / Kombizange	6	580 016 10	205	40 07157 50859 1
180 mm Combination Pliers / Kombizange	6	580 018 10	249	40 07157 50861 4

581



AC 1000V
IEC 60900 : 2004

		Item No		EAN-Code
160 mm Diagonal Nippers / Seitenschneider	6	581 016 10	214	40 07157 50863 8
180 mm Diagonal Nippers / Seitenschneider	6	581 018 10	249	40 07157 50865 2

582



AC 1000V
IEC 60900 : 2004

		Item No		EAN-Code
170 mm Chain Nose Radio Pliers / Telefonzange	6	582 017 10	159	40 07157 50869 0

582



AC 1000V
IEC 60900 : 2004

		Item No		EAN-Code
205 mm Chain Nose Radio Pliers Angled 45°	6	582 225 10	204	40 07157 50871 3

Telefonzange 45° gebogen

583



AC 1000V
IEC 60900 : 2004





		Item No		EAN-Code
160 mm Insulation Stripping Pliers	6	583 016 10	180	40 07157 50867 6

Abisolierzange

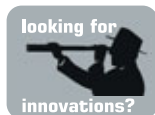
Display

400





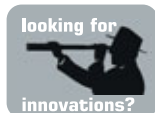

	Item No		EAN-Code
Display for 5 ERGONIC Sets / Display für 5 ERGONIC Sätze [230 mm x 120 mm x 440 mm] (5 x) 400 931 18	400 905 10	1970	40 07157 61303 5
Display for 5 ERGONIC Sets VDE / Display für 5 ERGONIC Sätze VDE (5 x) 413 931 94    AC 1000V IEC 60900 : 2004	413 905 90	1680	40 07157 61341 7

Customized selections upon request / Individuelle Zusammenstellungen auf Anfrage

400



	Item No		EAN-Code
Display for 7 ERGONIC Sets / Display für 7 ERGONIC Sätze [280 mm x 265 mm x 450 mm] (7 x) 400 951 18	400 907 10	3800	40 07157 61377 6
Display for 7 ERGONIC Sets VDE / Display für 7 ERGONIC Sätze VDE (7 x) 413 961 98    AC 1000V IEC 60900 : 2004	413 907 90	3895	40 07157 61375 2

Customized selections upon request / Individuelle Zusammenstellungen auf Anfrage

160

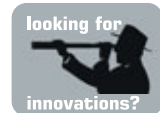

370



Item No



EAN-Code

Display for 12 Magazine Handles / Display für 12 Magazingriffe **376 912 00** 2970 40 07157 61333 2

[280 mm x 265 mm x 450 mm]

[6 x] **374 004 05**

[6 x] **376 041 05**

Customized selections upon request / Individuelle Zusammenstellungen auf Anfrage



020



Item No



EAN-Code

Display for 10 Swift Boxes / Display für 10 Swift Boxen **020 910 00** 790 40 07157 61343 1

[5 x] **020 601 16**

[5 x] **020 601 76**

Customized selections upon request / Individuelle Zusammenstellungen auf Anfrage



400



Item No



EAN-Code

Display for 8 Bit Boxes / Display für 8 Bit Boxen **020 138 70** 926 40 07157 61379 0

[8 x] **020 917 16)**

Customized selections upon request / Individuelle Zusammenstellungen auf Anfrage

Display **RGONIC**[®]

400









		Item No		EAN-Code
Display 58-tlg.	(460 mm / 350 mm / 210 mm)	400 991 10	6005	40 07157 53703 4
400:	2,5 x 75 (6 St./pcs.) / 3,5 x 100 (6 St./pcs.)			
	4,0 x 100 (6 St./pcs.) / 5,5 x 125 (5 St./pcs.)			
	6,5 x 150 (5 St./pcs.) / 8,0 x 175 (4 St./pcs.)			
401:	PZ 1 x 80 (6 St./pcs.) / PZ 2 x 100 (5 St./pcs.)			
402:	PH 1 x 80 (6 St./pcs.) / PH 2 x 100 (5 St./pcs.)			
	PH 3 x 150 (4 St./pcs.)			

Standard Display 11 Pegs, empty / 11 Haken, leer

391 011 00

410



		Item No		EAN-Code
Display 63-tlg.	(460 mm / 350 mm / 210 mm)	410 991 40	6277	40 07157 53311 1
410:	4,0 x 75 (6 St./pcs) / 5,5 x 100 (5 St./pcs)			
	6,5 x 125 (5 St./pcs)			
411:	PZ 1 x 80 (6 St./pcs) / PZ 2 x 100 (5 St./pcs)			
412:	PH 1 x 80 (6 St./pcs) / PH 2 x 100 (5 St./pcs)			
413:	3,5 x 100 (8 St./pcs) / 4,0 x 100 (6 St./pcs)	  		AC 1000V IEC 60900 : 2004
414:	PH 1 x 80 (6 St./pcs) / PH 2 x 100 (5 St./pcs)	  		AC 1000V IEC 60900 : 2004

Standard Display 11 Pegs, empty / 11 Haken, leer

391 011 00

400



AC 1000V
IEC 60900 : 2004



		Item No		EAN-Code
Display 61-tlg.	(460 mm / 350 mm / 210 mm)	413 991 90	5336	40 07157 53705 8
413:	2,5 x 75 (6 St./pcs.) / 3,0 x 100 (6 St./pcs.)			
	3,5 x 100 (6 St./pcs.) / 4,0 x 100 (6 St./pcs.)			
	4,5 x 125 (5 St./pcs.) / 5,5 x 125 (5 St./pcs.)			
	6,5 x 150 (5 St./pcs.)			
415:	PZ 2 x 100 (5 St./pcs.)			
414:	PH 0 x 60 (6 St./pcs.) / PH 1 x 80 (6 St./pcs.) / PH 2 x 100 (5 St./pcs.)			
Standard Display 11 Pegs, empty / 11 Haken, leer		391 011 00		

Display Serie 550

550



		Item No		EAN-Code
Display 41-tlg.	(460 mm / 390 mm / 230 mm)	550 993 40	7908	40 07157 53523 8
550:	4,5 x 100 (4 St./pcs.) / 5,5 x 100 (4 St./pcs.)			
	6,5 x 125 (4 St./pcs.) / 8,0 x 155 (4 St./pcs.)			
	10,0 x 175 (3 St./pcs.) / 12,0 x 200 (3 St./pcs.)			
551:	PZ 1 (4 St./pcs.) / PZ 2 (4 St./pcs.)			
552:	PH 1 (4 St./pcs.) / PH 2 (4 St./pcs.)			
	PH 3 (3 St./pcs.)			
Standard Display, empty / Standart Display, leer		391 014 00		

Display Serie 500



500



		Item No		EAN-Code
Display 72-tlg.	(460 mm / 350 mm / 210 mm)	500 992 10	6165	40 07157 50829 4
500:	5,5 x 25 (6 St./pcs) / 3,5 x 100 (8 St./pcs) 4,0 x 100 (7 St./pcs) / 5,5 x 125 (6 St./pcs) 6,5 x 150 (6 St./pcs) / 8,0 x 175 (5 St./pcs)			
501:	PZ 1 x 80 (7 St./pcs) / PZ 2 x 100 (6 St./pcs)			
502:	PH 0 x 60 (8 St./pcs) / PH 1 x 80 (7 St./pcs) PH 2 x 100 (6 St./pcs)			
Standard Display 11 Pegs, empty / 11 Haken, leer		391 011 00		

500



		Item No		EAN-Code
Display 74-tlg.	(460 mm / 350 mm / 210 mm)	500 994 10	6013	40 07157 51709 8
500:	4,0 x 100 (7 St./pcs) / 5,5 x 125 (6 St./pcs) 6,5 x 150 (6 St./pcs)			
501:	PZ 1 x 80 (7 St./pcs) / PZ 2 x 100 (6 St./pcs)			
502:	PH 1 x 80 (7 St./pcs) / PH 2 x 100 (6 St./pcs)			
513:	3,5 x 100 (8 St./pcs) / 4,0 x 100 (8 St./pcs)			AC 1000V IEC 60900 : 2004
514:	PH 1 x 80 (7 St./pcs) / PH 2 x 100 (6 St./pcs)			AC 1000V IEC 60900 : 2004
Standard Display 11 Pegs, empty / 11 Haken, leer		391 011 00		

500



		Item No		EAN-Code
Display 76-tlg.	(460 mm / 350 mm / 210 mm)	508 912 40	5653	40 07157 51711 1
508:	Torx 6 x 60 (10 St./pcs) / Torx 7 x 60 (8 St./pcs)			
	Torx 8 x 60 (8 St./pcs) / Torx 9 x 60 (8 St./pcs)			
	Torx 10 x 100 (7 St./pcs) / Torx 15 x 100 (7 St./pcs)			
	Torx 20 x 100 (6 St./pcs) / Torx 25 x 100 (6 St./pcs)			
	Torx 27 x 100 (6 St./pcs) / Torx 30 x 115 (5 St./pcs)			
	Torx 40 x 125 (5 St./pcs)			
Standard Display 11 Pegs, empty / 11 Haken, leer		391 011 00		

500



AC 1000V
IEC 60900 : 2004

		Item No		EAN-Code
Display 82-tlg.	(460 mm / 350 mm / 210 mm)	513 991 90	5667	40 07157 51863 7
513:	2,5 x 75 (10 St./pcs) / 3,0 x 100 (10 St./pcs)			
	3,5 x 100 (8 St./pcs) / 4,0 x 100 (8 St./pcs)			
	5,5 x 125 (6 St./pcs) / 6,5 x 150 (6 St./pcs)			
514:	PH 0 x 60 (8 St./pcs) / PH 1 x 80 (7 St./pcs)			
	PH 2 x 100 (6 St./pcs)			
515:	PZ 1 x 80 (7 St./pcs) / PZ 2 x 100 (6 St./pcs)			
Standard Display 11 Pegs, empty / 11 Haken, leer		391 011 00		

500





1/4"

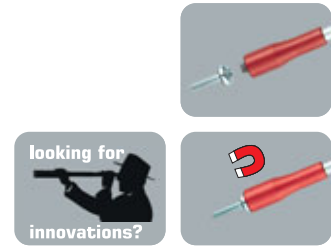

		Item No		EAN-Code
Display 68-tlg.	(460 mm / 350 mm / 210 mm)	500 996 10	7864	40 07157 51715 9
527:	4 x 100 (7 St./pcs) / 5 x 100 (6 St./pcs)			
	6 x 125 (6 St./pcs)			
528:	4 x 125 (7 St./pcs) / 5 x 125 (7 St./pcs)			
	6 x 125 (7 St./pcs) / 8 x 125 (6 St./pcs)			
	10 x 125 (6 St./pcs) / 13 x 125 (5 St./pcs)			
538:	1/4" x 100 (6 St./pcs)			
529:	1/4" x 170 (5 St./pcs)			
Standard Display 11 Pegs, empty / 11 Haken, leer		391 011 00		

500



		Item No		EAN-Code
Display 76-tlg. M-TEC	(460 mm / 350 mm / 210 mm)	500 991 30	5967	40 07157 51717 3
500:	3,0 x 80 (8 St./pcs) / 3,5 x 100 (8 St./pcs) 4 x 100 (7 St./pcs)			
501:	PZ 1 x 80 (7 St./pcs) / PZ 2 x 100 (6 St./pcs)			
502:	PH 1 x 80 (7 St./pcs) / PH 2 x 100 (6 St./pcs)			
508:	Torx 10 x 100 (8 St./pcs) / Torx 15 x 100 (7 St./pcs) Torx 20 x 100 (6 St./pcs) / Torx 25 x 100 (6 St./pcs)			
Standard Display 11 Pegs, empty / 11 Haken, leer		391 011 00		

Display Serie 600

613





AC 1000V
IEC 60900 : 2004

		Item No		EAN-Code
IEC Display 80-tlg.	(460 mm / 350 mm / 210 mm)	613 992 90	5382	40 07157 50837 9
613:	2,5 x 75 (9 St./pcs) / 3,0 x 100 (9 St./pcs) 3,5 x 100 (8 St./pcs) / 4,0 x 100 (7 St./pcs) 5,5 x 125 (6 St./pcs) / 6,5 x 150 (6 St./pcs)			
614:	PH 0 x 60 (9 St./pcs) / PH 1 x 80 (7 St./pcs) PH 2 x 100 (6 St./pcs)			
615:	PZ 1 x 80 (7 St./pcs) / PZ 2 x 100 (6 St./pcs)			
Standard Display 11 Pegs, empty / 11 Haken, leer		391 011 00		

Display Serie 206

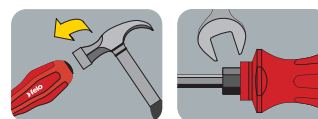
206



		Item No		EAN-Code
Display 41-tlg.	(460 mm / 350 mm / 210 mm)	206 992 90	6280	40 07157 57797 9
200:	4,0 x 100 (4 St./pcs)			
206:	5,5 x 100 (4 St./pcs) / 6,5 x 125 (4 St./pcs) 8,0 x 150 (4 St./pcs) / 10,0 x 175 (3 St./pcs) 12,0 x 200 (3 St./pcs)			
201:	PZ 1 x 80 (4 St./pcs)			
216:	PZ 2 x 100 (4 St./pcs)			
202:	PH 1 x 80 (4 St./pcs)			
226:	PH 2 x 100 (4 St./pcs) / PH 3 x 150 (3 St./pcs)			
Standard Display, empty / <i>Standart Display, leer</i>		391 014 00		

Display Serie 200

200



		Item No		EAN-Code
Display 75-tlg.	(460 mm / 350 mm / 210 mm)	200 994 90	5438	40 07157 50841 6
200:	3,5 x 100 (8 St./pcs) / 4,0 x 100 (7 St./pcs) 5,5 x 25 (6 St./pcs) / 5,5 x 125 (6 St./pcs) 6,5 x 150 (6 St./pcs)			
201:	PZ 0 x 60 (8 St./pcs) / PZ 1 x 80 (7 St./pcs) PZ 2 x 100 (6 St./pcs)			
202:	PH 0 x 60 (8 St./pcs) / PH 1 x 80 (7 St./pcs) PH 2 x 100 (6 St./pcs)			
Standard Display 11 Pegs, empty / <i>11 Haken, leer</i>		391 011 00		

200



		Item No		EAN-Code
Display 73-tlg.	(460 mm / 350 mm / 210 mm)	200 997 90	5790	40 07157 51753 1
200:	4,0 x 100 (7 St./pcs) / 5,0 x 125 (6 St./pcs)			
	6,5 x 125 (6 St./pcs)			
201:	PZ 1 x 80 (7 St./pcs) / PZ 2 x 100 (6 St./pcs)			
202:	PH 1 x 80 (7 St./pcs) / PH 2 x 100 (6 St./pcs)			
613:	3,5 x 100 (8 St./pcs) / 4,0 x 100 (7 St./pcs)			AC 1000V IEC 60900 : 2004
614:	PH 1 x 80 (7 St./pcs) / PH 2 x 100 (6 St./pcs)			AC 1000V IEC 60900 : 2004

Standard Display 11 Pegs, empty / 11 Haken, leer

391 011 00

200



		Item No		EAN-Code
Display 74-tlg.	(460 mm / 350 mm / 210 mm)	208 991 90	5469	40 07157 51755 5
208:	Torx 6 (8 St./pcs) / Torx 7 (8 St./pcs)			
	Torx 8 (8 St./pcs) / Torx 9 (8 St./pcs)			
	Torx 10 (7 St./pcs) / Torx 15 (7 St./pcs)			
	Torx 20 (6 St./pcs) / Torx 25 (6 St./pcs)			
	Torx 27 (6 St./pcs) / Torx 30 (5 St./pcs)			
	Torx 40 (5 St./pcs)			

Standard Display 11 Pegs, empty / 11 Haken, leer

391 011 00

Display smart

060



		Item No		EAN-Code
Display 8-tlg.	(275 mm / 185 mm / 280 mm)	060 985 00	4722	40 07157 50857 7
(8 x)	Smart Pouch 060 809 04			

168

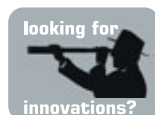

Display Serie 240/250

240



	Item No		EAN-Code
Boxen-Display 10-tlg. (220 mm / 290 mm / 250 mm)	240 961 50	3243	40 07157 50018 2
(5 x) 240: 240 961 56			
(5 x) 248: 248 961 56			
Display Boxen 240 empty / leer	391 023 00		

240



	Item No		EAN-Code
Display 48-tlg. (250 mm / 290 mm / 150 mm)	240 990 50	1844	40 07157 31804 6
(4 x 6) 240: 2,5 x 60 / 3,0 x 60			
3,5 x 100 / 4,0 x 100			
(2 x 6) 241: PZ 0 x 60 / PZ 1 x 80			
(2 x 6) 242: PH 0 x 60 / PH 1 x 80			
Display Serie 240, 8 Pegs, empty / 8 Haken, leer	391 020 00		

240



	Item No		EAN-Code
Kombi-Display (220 mm / 290 mm / 250 mm)	240 951 50	2563	40 07157 51703 6
(5 x) 240: 240 961 56			
(6 x) 248: TX 6 x 60			
(6 x) 240: 2,5 x 60 \ 3,5 x 100			
(6 x) 242: PH 0 x 60			

280



Item No



EAN-Code

Boxen-Display 10-tlg. (260 mm / 300 mm / 220 mm)

280 961 10

2933

40 07157 50753 2

(5 x) **280:** **280 907 06**

(5 x) **280:** **280 907 26**

250



ESD Safe
10⁸ - 10¹⁰ Ω



Item No



EAN-Code

Boxen-Display 10-tlg. (260 mm / 300 mm / 220 mm)

250 961 80

3318

40 07157 50296 4

(10 x) **250:** **250 961 86**

Display Serie 330

330

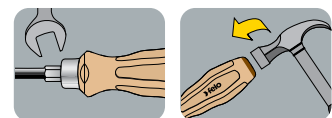

Item No



EAN-Code

Display 41-tlg. (460 mm / 350 mm / 210 mm)

335 991 90

7450

40 071575 7799 3

(4 x 4) **335:** 4,5 x 90 / 5,5 x 100 /

7,0 x 125 / 9,0 x 150

(2 x 3) 10,0 x 175 / 12,0 x 200

(2 x 4) **336:** PZ 1 x 80 / PZ 2 x 100

(1 x 3) PZ 3 x 150

(2 x 4) **337:** PH 1 x 80 / PH 2 x 100

Standard Display, empty / Standart Display, leer

391 014 00

170

Display Bits



Challenger

 **Diamond coated**



Item No







EAN-Code

Bit Display Diamant (155 Bits) (460 mm / 350 mm / 210 mm)			391 600 90	2631	40 07157 52219 1
5 x 020 520 86	1 St./ pcs.	5,5 x 1,0 x 25 mm			
5 x 020 610 86	1 St./ pcs.	6,5 x 1,2 x 25 mm			
5 x 020 800 86	1 St./ pcs.	8,0 x 1,2 x 25 mm			
5 x 021 010 86	1 St./ pcs.	PZ 1 x 25 mm			
5 x 021 022 86	2 St./ pcs.	PZ 2 x 25 mm			
5 x 021 030 86	1 St./ pcs.	PZ 3 x 25 mm			
5 x 021 932 86	3 x 1 St./pcs.	PZ 1 / PZ 2 / PZ 3 x 25 mm			
5 x 031 025 86	1 St./ pcs.	PZ 2 x 50 mm			
5 x 022 010 86	1 St./ pcs.	PH 1 x 25 mm			
5 x 022 022 86	2 St./ pcs.	PH 2 x 25 mm			
5 x 022 030 86	1 St./ pcs.	PH 3 x 25 mm			
5 x 022 931 86	3 x 1 St./pcs.	PH 1 / PH 2 / PH 3 x 25 mm			
5 x 032 015 86	1 St./ pcs.	PH 1 x 50 mm			
5 x 032 025 86	1 St./ pcs.	PH 2 x 50 mm			
5 x 026 100 86	1 St./ pcs.	Torx 10 x 25 mm			
5 x 026 150 86	1 St./ pcs.	Torx 15 x 25 mm			
5 x 026 202 86	2 St./ pcs.	Torx 20 x 25 mm			
5 x 026 252 86	2 St./ pcs.	Torx 25 x 25 mm			
5 x 026 300 86	1 St./ pcs.	Torx 30 x 25 mm			
5 x 026 400 86	1 St./ pcs.	Torx 40 x 25 mm			
5 x 026 933 86	3 x 1 St./pcs.	Torx 15 / Torx 20 / Torx 25 x 25 mm			









TiN Plus

			Item No		EAN-Code
	Bit Display TiN (450 Bits) (460 mm / 350 mm / 210 mm)		391 500 90	5216	40 07157 52217 7
	10 x 020 520 67	2 St./ pcs.	5,5 x 1,0 x 25 mm		
	10 x 020 610 67	2 St./ pcs.	6,5 x 1,2 x 25 mm		
	10 x 020 800 67	2 St./ pcs.	8,0 x 1,2 x 25 mm		
	10 x 030 525 67	2 St./ pcs.	5,5 x 1,5 x 50 mm		
	10 x 021 010 67	2 St./ pcs.	PZ 1 x 25 mm		
	10 x 021 020 67	2 St./ pcs.	PZ 2 x 25 mm		
	10 x 021 030 67	2 St./ pcs.	PZ 3 x 25 mm		
	10 x 021 932 67	3 x 1 St./pcs.	PZ 1 / PZ 2 / PZ 3 x 25 mm		
	10 x 031 025 67	2 St./ pcs.	PZ 2 x 50 mm		
	10 x 022 010 67	2 St./ pcs.	PH 1 x 25 mm		
	10 x 022 020 67	2 St./ pcs.	PH 2 x 25 mm		
	10 x 022 030 67	2 St./ pcs.	PH 3 x 25 mm		
	10 x 022 931 67	3 x 1 St./pcs.	PH 1 / PH 2 / PH 3 x 25 mm		
	10 x 032 025 67	2 St./ pcs.	PH 2 x 50 mm		
	10 x 026 100 67	2 St./ pcs.	Torx 10 x 25 mm		
	10 x 026 150 67	2 St./ pcs.	Torx 15 x 25 mm		
	10 x 026 200 67	2 St./ pcs.	Torx 20 x 25 mm		
	10 x 026 250 67	2 St./ pcs.	Torx 25 x 25 mm		
	10 x 026 300 67	2 St./ pcs.	Torx 30 x 25 mm		
	10 x 026 400 67	2 St./ pcs.	Torx 40 x 25 mm		
	10 x 026 933 67	3 x 1 St./pcs.	Torx 15 / Torx 20 / Torx 25 x 25 mm		









Industrial

			Item No		EAN-Code
	Bit Display Standard (430 Bits) (460 mm / 350 mm / 210 mm)		391 400 90	5256	40 07157 52215 3
	10 x O20 520 36	2 St./ pcs.	5,5 x 1,0 x 25 mm		
	10 x O20 610 36	2 St./ pcs.	6,5 x 1,2 x 25 mm		
	10 x O20 800 36	2 St./ pcs.	8,0 x 1,2 x 25 mm		
	10 x O21 010 36	2 St./ pcs.	PZ 1 x 25 mm		
	10 x O21 020 36	2 St./ pcs.	PZ 2 x 25 mm		
	10 x O21 030 36	2 St./ pcs.	PZ 3 x 25 mm		
	10 x O21 932 16	3 x 1 St./pcs.	PZ 1 / PZ 2 / PZ 3 x 25 mm		
	10 x O31 025 36	2 St./ pcs.	PZ 2 x 50 mm		
	10 x O22 010 36	2 St./ pcs.	PH 1 x 25 mm		
	10 x O22 020 36	2 St./ pcs.	PH 2 x 25 mm		
	10 x O22 030 36	2 St./ pcs.	PH 3 x 25 mm		
	10 x O22 931 16	3 x 1 St./pcs.	PH 1 / PH 2 / PH 3 x 25 mm		
	10 x O32 025 36	2 St./ pcs.	PH 2 x 50 mm		
	10 x O26 100 36	2 St./ pcs.	Torx 10 x 25 mm		
	10 x O26 150 36	2 St./ pcs.	Torx 15 x 25 mm		
	10 x O26 200 36	2 St./ pcs.	Torx 20 x 25 mm		
	10 x O26 250 36	2 St./ pcs.	Torx 25 x 25 mm		
	10 x O26 300 36	2 St./ pcs.	Torx 30 x 25 mm		
	10 x O26 400 36	2 St./ pcs.	Torx 40 x 25 mm		
	10 x O26 933 16	3 x 1 St./pcs.	Torx 15 / Torx 20 / Torx 25 x 25 mm		
	10 x O38 103 96	1 St./ pcs .	Magnethalter E 6,3 1/4" x 60		



Industrial

	Item No		EAN-Code
Bit Display Profi (186 tlg.) (460 mm / 350 mm / 210 mm)	391 700 90	3939	40 07157 52249 8
 5 x 026 060 36	2 St./ pcs.	Torx 6 x 25 mm	
5 x 026 080 36	2 St./ pcs.	Torx 8 x 25 mm	
5 x 026 090 36	2 St./ pcs.	Torx 9 x 25 mm	
5 x 036 931 16	3 x 1 St./pcs.	Torx 10 / Torx 15 / Torx 20 x 50 mm	
5 x 036 932 16	3 x 1 St./pcs.	Torx 20 / Torx 25 / Torx 30 x 50 mm	
 5 x 024 250 36	2 St./ pcs.	2,5 mm	
5 x 024 300 36	2 St./ pcs.	3 mm	
5 x 024 400 36	2 St./ pcs.	4 mm	
5 x 024 500 36	2 St./ pcs.	5 mm	
5 x 024 600 36	2 St./ pcs.	6 mm	
5 x 024 800 36	2 St./ pcs.	8 mm	
 5 x 032 931 16	3 x 1 St./pcs.	PH 1/ PH 2 / PH 3 x 50 mm	
5 x 031 932 16	3 x 1 St./pcs.	PZ 1/ PZ 2 / PZ 3 x 50 mm	
 5 x 032 932 16	3 x 1 St./pcs.	PH 2 / PZ 2 / 5,5 x 0,8 x 50 mm	
 5 x 030 931 16	3 x 1 St./pcs.	3,5 x 0,6 / 5,5 x 0,8 / 6,5 x 1,2 x 50 mm	
5 x 038 109 96	1 St./ pcs.	Magnethalter extra stark	
5 x 038 165 96	1 St./ pcs.	Star	
5 x 037 103 96	1 St./ pcs.	Mech. Bithalter	
5 x 097 018 16	1 St./ pcs.	1/4" Adapter	
5 x 097 013 16	1 St./ pcs.	1/4" Adapter	
5 x 097 020 16	1 St./ pcs.	3/8" Adapter	



Industrial

	Item No		EAN-Code
Display für Runddosen, 20 tlg. (200 mm x 128 mm x 23,5 mm)	391 250 90	2516	40 07157 50622 1
(10 x) 020:	Bit-Box, 6 Bits + Magnethalter (Art.No.020 974 60)		
(10 x) 023:	Torx-Box, 6 Bits + Magnethalter (Art.No.023 974 60)		
Stand for Bit Boxes / Ständer Bit Dosen	391 017 00		

391





Item No



EAN-Code

Bit-Tray / Zahlteller (275 mm x 270 mm x 33 mm)

020 950 06

2129

40 07157 51317 5

10 x PH 1 x 25 TIN / 20 x PH 2 x 25 TIN / 10 x PH 3 x 25 TIN

10 x PZ 1 x 25 TIN / 20 x PZ 2 x 25 TIN / 10 x PZ 3 x 25 TIN

10 x Torx 10 x 25 TIN / 10 x Torx 15 x 25 TIN / 10 x Torx 20 x 25 TIN

10 x Torx 25 x 25 TIN / 10 x Torx 30 x 25 TIN / 10 x Torx 40 x 25 TIN

10 x PZ 1 x 25 Diamant / 20 x PZ 2 x 25 DIA

20 x PH 2 x 25 Diamant / 10 x PH 2 x 50 TIN

10 x PZ 2 x 50 TIN

10 x Torx 15 x 50 TIN / 10 x Torx 20 x 50 TIN / 10 x Torx 25 x 50 TIN / 10 x Torx 30 x 50 TIN

6 x Adapter 6,3 1/4" 4-kt / 6 x Adapter 3/8" 50mm

5 x Steckschlüssel Hex 8 x 66 / 5 x Steckschlüssel Hex 10 x 66 / 4 x Steckschlüssel Hex 13 x 66

12 x Magnethalter 1/4" x 47 / 12 x Magnethalter 1/4" x 58



Item No



EAN-Code

Bit-Tray / Zahlteller (275 mm x 270 mm x 33 mm)

020 951 06

2038

40 07157 51687 9

10 x PZ 1 x 25 / 20 x PZ 2 x 25 / 10 x PZ 3 x 25

10 x PH 1 x 25 / 20 x PH 2 x 25 / 10 x PH 3 x 25

10 x Torx 15 x 25 / 10 x Torx 20 x 25 / 10 x Torx 25 x 25 / 10 x Torx 30 x 25

10 x PZ 1 x 25 TIN / 10 x PZ 2 x 25 TIN / 10 x PZ 3 x 25 TIN

10 x PH 1 x 25 TIN / 10 x PH2 x 25 TIN / 10 x PH 3 x 25 TIN

10 x PZ 1 x 50 / 10 x PZ 2 x 50

10 x PH 1 x 50 / 10 x PH 2 x 50

10 x 0,5 x 4,0 / 10 x 0,6 x 4,5 / 10 x 0,8 x 5,5

12 x Magnethalter 1/4"

6 x Adapter 1/4" x 25 mm / 6 x Adapter 3/8" x 50 mm / 6 x Adapter E 6,3 x 50 mm

4 x Felo Star



1/4"



1/4"

Display *felo star*

038



		Item No		EAN-Code
Felo Star Clipstrip (850 mm x 50 mm)	1	038 012 90	494	40 07157 53049 3
(12 x)	038 165 94			

038

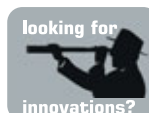

		Item No		EAN-Code
Star Display (345 mm / 245 mm / 170 mm)		038 024 90	1397	40 07157 51431 8
(24 x)	038 165 90			

Display **felo** swift

038



			Item No		EAN-Code
Clipstrip TiN Universal	(85 x 10 cm)	1	020 381 00	1058	40 07157 53047 9
(12 x)	020 601 71				
Clipstrip Universal	(85 x 10 cm)	1	020 380 00	1058	40 07157 53045 5
(12 x)	020 601 11				
Clipstrip TORX	(85 x 10 cm)	1	020 382 00	1070	40 07157 53177 3
(12 x)	020 603 11				

020



			Item No		EAN-Code
Holz TiN / Universal TiN		1	020 360 00	2574	40 07157 51529 2
(18 x)	02060576 + 18 x 02060176				
Universal / Torx		1	020 363 00	2610	40 07157 51535 3
(18 x)	02060116 + 18 x 02060316				
PZ PH TiN / Universal		1	020 364 00	2784	40 07157 51537 7
(18 x)	02060376 + 18 x 02060116				
Universal / Universal TiN		1	020 367 00	2748	40 07157 51551 3
(18 x)	02060116 + 18 x 02060176				
PZ PH TiN		1	020 368 00	2784	40 07157 51611 4
(36 x)	02060376				

Display Pliers / Zangen

590



		Item No		EAN-Code
Display 20-tlg.	(460 mm / 350 mm / 210 mm)	590 920 10	5768	40 07157 50847 8
(4 x)	Combination Pliers / Kombizange 160 mm			
(4 x)	Heavy-duty Diagonal Nippers / Kraftseitenschneider 180 mm			
(4 x)	Diagonal Nippers / Seitenschneider 160 mm			
(4 x)	Chain Nose Radio Pliers / Telefonzange 200 mm			
(4 x)	Insulation Stripping Pliers / Abisolierzange 160 mm			

Display empty / leer

391



Bit-Schütze

empty / leer

Item No		EAN-Code
391 015 00	4359	

391



AllStar / swift Display

empty / leer

Item No

391 043 00



1088

EAN-Code

391



AllStar Display

empty / leer

Item No

391 026 00



981

EAN-Code

391



T-Handle Display, per hook / Display T-Griff, pro Haken

empty / leer

Item No

391 024 00



153

EAN-Code

Intelligent sales concepts for the specialist trade and ideal product presentation. We will give you professional advice and develop a concept to suit your needs.

*Durchdachte Fachhandels-Konzepte und optimale Präsentationen.
Wir beraten Sie gerne und entwickeln ein auf Sie
abgestimmtes Konzept*



In addition to the products shown below, we have a further 120 tools for professionals and 20 quality pliers in our program.

Neben den unten genannten Artikeln führen wir weitere 120 Profi-Werkzeuge und 20 Qualitäts-Zangen.



**Combi tools:
Choose from 28 types**
*Kombi-Werkzeuge:
Wählen Sie aus
28 Sortimenten*

**Precision
screwdrivers:
Choose from
60 individual tools,
9 different sets
or 10 displays**
*Präzisions-
Schraubendreher:
Wählen Sie aus
60 Werkzeugen und
9 verschiedenen Sets
oder 10 Displays*

**Bit boxes:
Choose from 53 boxes
or 20 displays**
*Bitboxen:
Wählen Sie aus
53 Boxen und
20 Displays*

**Screwdriver sets:
Choose from
over 50 varieties**
*Schraubendreher-Sätze:
Wählen Sie aus
über 50 Varianten*

**Screwdrivers:
Choose from
400 screwdrivers or
23 filled displays**
*Schraubendreher:
Wählen Sie aus
400 Schraubendrehern
und 23 bestückten
Displays*

**Bits:
Choose from 340 bits
or 50 PP boxes**
*Bits:
Wählen Sie aus
340 Bits und
50 SB-Verpackungen*

**T-handles: Choose
from 40 individual
tools and 2 sets**
*T-Griffe:
Wählen Sie aus
40 Werkzeugen
und 2 Sets*

Retail displays are available as 1m core-assortment modules for intelligent and convincing sales presentation even in limited spaces.

Fachhandels-Sortimente sind auch als 1m Kern-Module erhältlich. Selbst bei geringem Platzangebot überzeugen die durchdachten Warenpräsentationen.



Stickers in various languages informative pictograms clearly explaining product features! Stickers for item numbers and prices

Kopfschilder in Landessprachen und Piktogramme erklären Produktvorteile. Der Kunde wird klar informiert! Auszeichnungstreifen für Preisinformation und Artikelnummer



Convincing displays for small items: Our new ready-to-sell Swift displays for placement on the sales counter.

Überzeugende Displays für kleine Produkte: Unsere neuen verkaufsfertigen Swift Displays für die Verkaufstheke.

More on pages 150 - 151.
Mehr auf den Seiten 150 - 151.



Felo Star
A sure sales booster with innovative products
Displays made of high-quality acrylic glass.

Felo Star:
Eine Garantie für Umsatz mit innovativen Produkten.
Thekendisplays aus hochwertigem Acrylglas.



Convincing POS support going hand in hand with new product lines.

Überzeugende Verkaufsunterstützung die Hand-in-Hand mit neuen Produkten geht.



Your partner for

- **innovative products**
- **extensive variety**
- **highest quality standards**
- **convincing sales support**
- **fast delivery**

Ihr Partner für

- *innovative Produkte*
- *umfassende Sortimentstiefe*
- *höchste Qualitätsstandards*
- *durchdachte Verkaufshilfen*
- *schnellen Lieferservice*

Article Index / Artikel Index

Item No	Page Seite
010 315 10	146
010 415 10	146
010 505 10	146
010 515 10	146
010 525 10	146
010 605 10	146
010 615 10	146
010 805 10	146
011 015 10	146
011 025 10	146
011 035 10	146
012 015 10	146
012 025 10	146
012 035 10	146
014 255 10	146
014 305 10	146
014 405 10	146
014 505 10	146
014 605 10	146
018 102 90	154
020 026 16	140
020 026 76	140
020 103 10	110
020 126 16	141
020 138 70	161
020 210 10	110
020 226 16	142
020 300 10	110
020 310 10	110
020 310 36	122
020 326 16	142
020 353 10	110
020 360 00	177
020 363 00	177
020 364 00	177
020 367 00	177
020 368 00	177
020 380 00	177
020 381 00	177
020 382 00	177
020 400 10	110
020 400 80	104
020 410 10	110
020 410 36	122
020 413 10	110
020 423 10	110
020 423 36	122
020 500 10	110
020 500 36	122

Item No	Page Seite
020 500 67	121
020 500 70	106
020 503 10	110
020 510 10	110
020 510 36	122
020 513 10	110
020 520 10	110
020 520 36	122
020 520 67	121
020 520 70	106
020 520 80	104
020 520 86	120
020 523 10	110
020 523 36	122
020 600 10	110
020 601 11	131
020 601 16	131
020 601 71	129
020 601 76	129
020 602 11	131
020 602 16	131
020 602 71	129
020 602 76	129
020 603 81	130
020 603 10	110
020 603 11	131
020 603 16	131
020 603 21	131
020 603 26	131
020 603 71	130
020 603 76	130
020 603 86	130
020 604 71	130
020 604 76	130
020 605 71	130
020 605 76	130
020 608 71	130
020 608 76	130
020 610 10	110
020 610 11	131
020 610 16	131
020 610 36	122
020 610 67	121
020 610 70	106
020 610 80	104
020 610 86	120
020 613 10	110
020 730 06	132
020 735 16	133

Item No	Page Seite
020 738 06	132
020 800 10	110
020 800 36	122
020 800 67	121
020 800 70	106
020 800 80	104
020 800 86	120
020 803 10	110
020 813 10	110
020 901 16	126
020 901 76	125
020 901 86	125
020 902 16	127
020 902 76	125
020 903 76	128
020 904 76	128
020 906 10	114
020 908 10	114
020 910 00	161
020 910 10	114
020 910 16	136
020 912 06	56
020 917 16	134
020 931 16	122
020 931 67	121
020 932 16	122
020 932 67	121
020 933 16	122
020 934 16	122
020 950 06	175
020 951 06	175
020 974 60	143
020 974 61	143
020 994 60	143
020 994 61	143
020 995 06	139
020 997 06	139
021 000 10	111
021 010 10	111
021 010 17	111
021 010 36	122
021 010 56	122
021 010 67	121
021 010 70	106
021 010 80	104
021 010 86	120
021 012 36	122
021 012 67	121
021 012 86	120

Item No	Page Seite
021 020 10	111
021 020 17	111
021 020 36	122
021 020 56	122
021 020 57	121
021 020 67	121
021 020 70	106
021 020 80	104
021 022 86	120
021 023 36	122
021 023 67	121
021 025 10	111
021 025 70	107
021 026 16	142
021 030 10	111
021 030 17	111
021 030 36	122
021 030 56	122
021 030 67	121
021 030 70	106
021 030 80	104
021 030 86	120
021 032 86	120
021 035 10	111
021 035 70	107
021 042 10	111
021 910 76	134
021 932 16	122
021 932 67	121
021 932 86	120
022 000 10	111
022 002 70	106
022 010 10	111
022 010 17	111
022 010 36	122
022 010 56	122
022 010 67	121
022 010 70	106
022 010 80	104
022 010 86	120
022 012 36	122
022 012 67	121
022 020 10	111
022 020 17	111
022 020 36	122
022 020 56	122
022 020 57	121
022 020 67	121
022 020 70	106
022 020 80	104
022 022 86	120
022 023 36	122
022 025 10	111
022 025 70	107
022 030 10	111
022 030 17	111
022 030 36	122

Item No	Page Seite
022 030 67	121
022 030 70	106
022 030 80	104
022 030 86	120
022 035 10	111
022 035 70	107
022 042 10	111
022 910 16	136
022 910 76	134
022 931 16	122
022 931 67	121
022 931 86	120
023 060 10	113
023 070 10	113
023 080 10	113
023 090 10	113
023 100 10	113
023 150 10	113
023 200 10	113
023 250 10	113
023 270 10	113
023 300 10	113
023 400 10	113
023 974 60	143
023 974 61	143
023 995 60	139
024 200 10	112
024 200 36	122
024 250 10	112
024 250 36	122
024 300 10	112
024 300 36	122
024 400 10	112
024 400 36	122
024 500 10	112
024 500 36	122
024 600 10	112
024 600 36	122
024 800 10	112
024 800 36	122
024 931 16	122
024 933 16	122
024 934 16	122
025 000 10	112
025 100 10	112
025 200 10	112
025 300 10	112
026 026 16	141
026 050 10	112
026 060 10	112
026 060 36	123
026 060 70	107
026 070 10	112
026 070 36	123
026 070 70	107
026 080 10	112
026 080 36	123

Item No	Page Seite
026 080 70	107
026 090 10	112
026 090 36	123
026 090 70	107
026 100 10	112
026 100 17	112
026 100 36	123
026 100 67	121
026 100 70	107
026 100 80	105
026 100 86	120
026 150 10	112
026 150 17	112
026 150 36	123
026 150 67	121
026 150 70	107
026 150 80	105
026 150 86	120
026 200 10	112
026 200 17	112
026 200 36	123
026 200 67	121
026 200 70	107
026 200 80	105
026 202 86	120
026 250 10	112
026 250 17	112
026 250 36	123
026 250 67	121
026 250 70	107
026 250 80	105
026 252 86	120
026 270 10	112
026 270 36	123
026 270 70	107
026 300 10	112
026 300 36	123
026 300 67	121
026 300 70	107
026 300 80	105
026 300 86	120
026 400 10	112
026 400 36	123
026 400 67	121
026 400 70	107
026 400 80	105
026 400 86	120
026 450 10	112
026 450 70	107
026 901 16	127
026 901 76	126
026 910 16	136
026 931 16	123
026 932 16	123
026 933 16	123
026 933 67	121
026 933 86	120

Item No	Page <i>Seite</i>
027 070 10	113
027 070 36	123
027 080 10	113
027 080 36	123
027 090 10	113
027 090 36	123
027 100 10	113
027 100 36	123
027 150 10	113
027 150 36	123
027 200 10	113
027 200 36	123
027 250 10	113
027 250 36	123
027 270 10	113
027 270 36	123
027 300 10	113
027 300 36	123
027 400 10	113
027 400 36	123
027 974 60	143
028 040 10	114
028 050 10	114
028 060 10	114
028 080 10	114
028 100 10	114
028 930 10	113
028 940 10	113
029 000 10	114
029 010 10	114
029 020 10	114
029 030 10	114
029 040 10	114
029 050 10	114
029 060 10	114
029 080 10	114
029 100 10	114
029 300 10	144
029 400 10	144
029 500 10	144
029 510 10	114
029 520 10	114
029 530 10	114
029 540 10	114
029 550 10	114
029 600 10	144
030 105 10	115
030 305 10	115
030 307 10	117
030 307 36	123
030 315 10	115
030 317 10	117
030 317 36	123
030 317 70	109
030 415 10	115
030 415 36	123
030 417 10	117

Item No	Page <i>Seite</i>
030 417 70	109
030 418 10	119
030 455 10	115
030 505 10	115
030 505 36	123
030 505 70	108
030 507 70	109
030 515 10	115
030 515 36	123
030 525 10	115
030 525 36	123
030 525 67	121
030 525 70	108
030 527 10	117
030 527 36	123
030 528 10	119
030 557 70	109
030 605 10	115
030 605 36	123
030 615 10	115
030 615 36	123
030 615 67	121
030 615 70	108
030 617 10	117
030 618 10	119
030 657 70	109
030 805 10	115
030 805 36	123
030 805 67	121
030 805 70	108
030 815 10	115
030 818 10	119
030 915 16	137
030 917 16	138
030 931 16	123
031 015 10	115
031 015 36	123
031 015 67	121
031 015 70	108
031 015 80	105
031 017 10	117
031 017 70	109
031 018 10	119
031 019 10	119
031 025 10	115
031 025 36	123
031 025 67	121
031 025 70	108
031 025 80	105
031 025 86	120
031 027 10	117
031 027 36	123
031 027 70	109
031 028 10	119
031 029 10	119
031 035 10	115
031 035 67	121

Item No	Page <i>Seite</i>
031 035 70	108
031 035 80	105
031 037 10	117
031 038 10	119
031 039 10	119
031 101 10	118
031 202 10	118
031 932 16	123
032 005 10	115
032 015 10	115
032 015 36	123
032 015 67	121
032 015 70	108
032 015 80	105
032 015 86	120
032 017 10	117
032 017 36	123
032 017 70	109
032 018 10	119
032 019 10	119
032 025 10	115
032 025 36	123
032 025 67	121
032 025 70	108
032 025 80	105
032 025 86	120
032 027 10	117
032 027 36	123
032 027 70	109
032 028 10	119
032 029 10	119
032 035 10	115
032 035 67	121
032 035 70	108
032 035 80	105
032 037 10	117
032 101 10	118
032 202 10	118
032 915 16	137
032 915 76	135
032 917 16	138
032 931 16	123
032 932 16	123
033 105 10	115
033 155 10	115
033 205 10	115
033 255 10	115
033 305 10	115
034 255 10	116
034 305 10	116
034 405 10	116
034 505 10	116
034 605 10	116
034 805 10	116
035 007 10	118
035 017 10	118
035 027 10	118

Item No	Page Seite
035 037 10	118
036 055 10	116
036 065 10	116
036 075 10	116
036 085 10	116
036 095 10	116
036 105 10	116
036 105 70	108
036 107 10	118
036 155 10	116
036 155 70	108
036 157 10	118
036 205 10	116
036 205 70	108
036 207 10	118
036 255 10	116
036 255 70	108
036 257 10	118
036 275 10	116
036 277 10	118
036 305 10	116
036 305 70	108
036 307 10	118
036 405 10	116
036 405 70	108
036 407 10	118
036 915 16	137
036 915 76	135
036 917 16	138
036 931 16	123
036 932 16	123
037 103 90	154
038 012 90	176
038 024 90	176
038 102 90	153
038 103 90	153
038 103 96	153
038 105 90	153
038 107 90	153
038 109 90	153
038 165 90	153
038 165 94	153
038 169 90	153
038 170 90	153
039 038 10	145
039 050 10	145
039 060 10	145
039 070 10	145
039 080 10	145
039 100 10	145
039 120 10	145
039 130 10	145
039 516 10	145
040 315 10	147
040 415 10	147
040 505 10	147
040 515 10	147

Item No	Page Seite
040 525 10	147
040 605 10	147
040 615 10	147
040 805 10	147
041 015 10	147
041 025 10	147
041 035 10	147
042 015 10	147
042 025 10	147
042 035 10	147
048 102 80	154
048 102 90	154
051 001 10	148
052 024 10	148
052 130 10	148
054 152 10	148
054 253 10	148
056 084 10	148
056 115 10	148
056 825 10	148
057 635 01	92
057 711 06	91
057 718 06	91
057 733 06	92
057 810 06	88
057 819 06	88
057 836 06	89
057 836 16	87
057 981 06	140
058 102 90	154
059 103 90	154
060 456 10	148
060 566 10	148
060 809 04	98
060 813 06	95
060 815 06	95
060 815 36	96
060 820 06	97
060 896 10	148
060 912 06	96
060 920 36	97
060 985 00	168
061 105 04	99
061 126 10	148
061 206 04	99
061 226 10	148
061 236 10	148
061 307 04	99
062 023 04	99
062 104 04	99
062 107 04	99
062 126 10	148
062 206 04	99
062 236 10	148
063 000 04	103
063 025 04	103
063 030 04	103

Item No	Page Seite
063 035 04	103
063 040 04	103
063 055 04	103
063 065 04	103
063 083 04	103
063 100 04	103
063 102 04	103
063 102 14	103
063 103 04	103
063 105 00	103
063 112 04	103
063 112 14	103
063 153 04	103
063 200 04	103
063 203 04	103
063 203 14	103
063 203 24	103
063 223 04	103
063 223 14	103
063 300 04	103
063 913 01	102
063 913 06	101
063 913 16	101
063 919 04	102
064 034 04	99
064 056 04	99
065 001 04	99
065 023 04	99
066 067 04	99
066 089 04	99
066 115 04	99
066 225 04	99
066 340 04	99
067 115 04	99
067 225 04	99
067 340 04	99
068 055 24	99
068 060 24	99
068 065 04	99
068 070 24	99
068 080 24	99
068 100 24	99
068 111 04	98
068 127 04	98
068 130 24	99
068 142 04	98
068 170 24	99
068 555 04	98
068 635 04	98
068 635 14	99
068 714 04	98
068 793 04	98
068 952 04	98
069 205 00	98
070 104 10	149
070 204 10	149
070 514 10	149

Item No	Page <i>Seite</i>
070 524 10	149
070 604 10	149
070 614 10	149
070 804 10	149
070 814 10	149
071 010 10	149
071 020 10	149
071 030 10	149
071 042 10	149
072 010 10	150
072 020 10	150
072 030 10	150
072 042 10	150
074 100 10	150
074 300 10	150
074 400 10	150
074 500 10	150
074 600 10	150
074 800 10	150
076 253 10	150
076 273 10	150
076 303 10	150
076 403 10	150
076 453 10	150
076 503 10	150
076 553 10	150
078 005 10	151
078 006 10	151
078 008 10	151
078 010 10	151
078 012 10	151
078 050 10	151
078 060 10	151
078 080 10	151
078 100 10	151
078 120 10	151
079 080 10	144
079 100 10	144
081 020 10	151
081 025 10	151
082 020 10	151
082 025 10	151
086 200 10	151
086 250 10	151
096 040 10	93
096 045 10	93
096 050 10	93
096 055 10	93
096 055 20	89
096 060 10	93
096 060 20	89
096 070 10	93
096 070 20	89
096 080 10	93
096 080 20	89
096 090 10	93
096 100 10	93

Item No	Page <i>Seite</i>
096 100 20	89
096 110 10	93
096 120 10	93
096 130 10	93
096 130 20	89
096 140 10	93
097 000 10	93
097 011 10	155
097 013 10	155
097 018 10	155
097 019 10	93
097 020 10	155
097 050 10	93
097 070 10	155
097 100 10	93
097 150 14	99
097 150 14	155
100 001 06	64
100 002 06	64
100 003 06	64
100 006 00	64
100 032 04	65
100 043 04	65
100 043 14	65
100 060 00	64
100 353 04	65
100 353 14	65
100 554 04	65
100 554 14	65
100 991 16	63
100 992 16	63
100 993 16	64
101 001 04	65
101 102 04	65
101 102 14	65
101 203 04	65
101 203 14	65
102 001 04	65
102 102 04	65
102 102 14	65
102 203 04	65
102 203 14	65
104 015 04	65
104 020 04	65
104 025 04	65
104 030 04	65
105 040 04	65
106 102 04	65
106 203 04	65
106 203 14	65
107 102 04	65
107 203 04	65
107 203 14	65
108 061 04	65
108 071 04	65
108 083 04	65
108 093 04	65

Item No	Page <i>Seite</i>
108 103 04	65
108 153 04	65
108 203 04	65
108 253 04	65
109 061 04	65
109 071 04	65
109 083 04	65
109 093 04	65
109 103 04	65
109 153 04	65
118 125 04	65
200 022 90	35
200 032 90	35
200 043 90	35
200 054 90	35
200 086 90	35
200 107 90	35
200 112 96	40
200 114 96	41
200 353 90	35
200 550 90	36
200 554 90	35
200 650 90	36
200 654 90	35
200 655 90	35
200 951 98	38
200 971 97	39
200 972 97	40
200 972 98	38
200 973 98	38
200 994 90	167
200 997 90	168
201 001 90	35
201 020 90	36
201 102 90	35
201 203 90	35
201 305 90	35
202 001 90	35
202 020 90	36
202 102 90	35
202 203 90	35
202 305 90	35
206 055 90	33
206 065 90	33
206 080 90	33
206 100 90	33
206 120 90	33
206 951 98	33
206 992 90	167
208 061 90	36
208 071 90	36
208 083 90	36
208 093 90	36
208 103 90	36
208 153 90	36
208 203 90	36
208 253 90	36

Item No	Page Seite
208 273 90	36
208 303 90	36
208 404 90	36
208 971 98	39
208 991 90	168
216 203 90	33
216 305 90	33
226 203 90	33
226 305 90	33
240 033 50	67
240 035 50	67
240 037 50	67
240 043 50	67
240 045 50	67
240 047 50	67
240 151 50	67
240 201 50	67
240 252 50	67
240 255 50	67
240 257 50	67
240 333 50	67
240 353 50	67
240 355 50	67
240 358 50	67
240 951 50	169
240 961 50	169
240 961 56	69
240 990 50	169
241 001 50	67
241 102 50	67
242 000 50	67
242 001 50	67
242 009 50	67
242 102 50	67
242 105 50	67
245 972 06	69
246 151 50	68
246 201 50	68
246 252 50	68
246 302 50	68
248 051 50	68
248 061 50	68
248 071 50	68
248 081 50	68
248 091 50	68
248 103 50	68
248 108 50	68
248 153 50	68
248 158 50	68
248 208 50	68
248 961 56	69
249 300 50	68
249 350 50	68
249 400 50	68
249 450 50	68
249 500 50	68
249 550 50	68

Item No	Page Seite
249 961 56	69
250 033 80	71
250 035 80	71
250 120 06	71
250 151 80	71
250 201 80	71
250 252 80	71
250 961 80	170
250 961 86	71
252 001 80	71
252 009 80	71
252 102 80	71
280 153 14	70
280 235 14	70
280 245 14	70
280 907 06	70
280 907 16	70
280 907 26	70
280 961 10	170
281 010 14	70
282 000 14	70
282 001 14	70
284 134 14	70
284 152 14	70
284 253 14	70
286 615 14	70
286 710 14	70
286 890 14	70
290 043 90	37
290 353 90	37
290 554 90	37
290 655 90	37
290 656 90	37
292 001 90	37
292 102 90	37
292 203 90	37
292 205 90	37
292 207 90	37
303 035 80	75
303 045 80	75
303 055 80	75
303 065 80	75
303 085 80	75
303 087 80	75
303 107 80	75
303 203 80	75
303 253 80	75
303 951 80	76
304 064 80	75
304 068 80	75
304 078 80	75
304 084 80	75
304 088 80	75
304 089 80	75
304 098 80	75
304 104 80	75
304 108 80	75

Item No	Page Seite
304 109 80	75
304 118 80	75
304 128 80	75
304 134 80	75
304 138 80	75
304 139 80	75
304 178 80	75
304 558 80	75
308 103 80	76
308 153 80	76
308 204 80	76
308 207 80	76
308 254 80	76
308 257 80	76
308 277 80	76
308 307 80	76
308 407 80	76
308 455 80	76
313 020 00	77
313 025 00	77
313 030 00	77
313 035 00	77
313 040 00	77
313 045 00	77
313 050 00	77
313 060 00	77
313 070 00	77
313 080 00	77
313 090 00	77
313 100 00	77
313 120 00	77
313 140 00	77
326 965 10	45
326 965 11	45
335 035 90	43
335 045 90	43
335 055 90	43
335 065 90	43
335 080 90	43
335 100 90	43
335 120 90	43
335 951 98	44
335 971 98	44
335 991 90	170
336 102 90	43
336 203 90	43
336 305 90	43
337 102 90	43
337 203 90	43
337 305 90	43
338 125 80	76
338 125 80	152
340 040 00	77
340 040 04	77
340 055 00	77
340 055 04	77
340 080 00	77

Item No	Page <i>Seite</i>
340 080 04	77
341 120 00	77
341 120 04	77
341 340 00	77
341 340 04	77
342 120 00	77
342 120 04	77
342 340 00	77
342 340 04	77
343 260 00	77
343 260 04	77
345 006 01	84
345 007 01	84
345 015 00	82
345 020 00	82
345 025 00	82
345 030 00	82
345 040 00	82
345 050 00	82
345 060 00	82
345 080 00	82
345 100 00	82
345 120 00	82
345 140 00	82
345 170 00	82
348 006 00	80
348 007 00	80
348 008 00	80
348 009 00	80
348 010 00	80
348 015 00	80
348 020 00	80
348 025 00	80
348 027 00	80
348 030 00	80
348 040 00	80
348 045 00	80
348 050 00	80
348 055 00	80
348 060 00	80
348 080 01	81
348 088 01	81
348 105 50	79
348 106 50	79
348 107 50	79
348 108 50	79
348 109 50	79
348 110 50	79
348 115 50	79
348 120 50	79
348 801 04	80
348 802 04	80
348 907 50	79
349 105 50	79
349 106 50	79
349 107 50	79
349 108 50	79

Item No	Page <i>Seite</i>
349 109 50	79
349 110 50	79
349 115 50	79
349 120 50	79
349 907 50	80
355 009 01	85
355 015 00	82
355 020 00	82
355 025 00	82
355 030 00	82
355 040 00	82
355 050 00	82
355 060 00	82
355 080 00	82
355 100 00	82
355 150 01	85
361 300 00	61
361 300 01	61
361 350 00	61
361 350 01	61
361 400 00	60
361 400 01	60
361 600 00	61
361 600 04	61
361 700 00	61
361 700 04	61
363 100 05	61
365 009 01	83
365 015 00	83
365 020 00	83
365 025 00	83
365 030 00	83
365 040 00	83
365 050 00	83
365 060 00	83
365 080 00	83
365 100 00	83
373 108 05	73
373 208 05	73
374 004 05	73
374 204 05	73
375 130 01	85
376 041 05	73
376 044 05	73
376 912 00	161
389 800 01	93
389 900 00	98
391 011 00	162
391 014 00	163
391 015 00	178
391 017 00	174
391 020 00	169
391 023 00	169
391 024 00	179
391 026 00	179
391 043 00	179
391 250 90	174

Item No	Page <i>Seite</i>
391 400 90	173
391 500 90	172
391 600 90	171
391 700 90	174
400 953 18	14
400 022 10	10
400 032 10	10
400 043 10	10
400 055 10	10
400 065 10	10
400 067 10	10
400 086 10	10
400 107 10	10
400 353 10	10
400 550 10	12
400 554 10	10
400 555 10	10
400 653 10	10
400 655 10	10
400 657 10	10
400 905 10	160
400 907 10	160
400 917 43	13
400 931 18	14
400 951 18	14
400 961 18	13
400 971 18	13
400 991 10	162
401 102 10	10
401 203 10	10
401 305 10	10
402 020 10	12
402 102 10	10
402 203 10	10
402 205 10	10
402 207 10	10
402 305 10	10
404 000 40	10
404 100 40	10
404 200 40	10
404 300 40	10
404 931 48	14
407 103 40	11
407 153 40	11
407 203 40	11
407 253 40	11
408 071 40	11
408 083 40	11
408 093 40	11
408 103 40	11
408 153 40	11
408 203 40	11
408 253 40	11
408 273 40	11
408 303 40	11
408 404 40	11
408 931 48	15

Item No	Page Seite
408 961 48	15
410 042 40	8
410 085 40	8
410 105 40	8
410 127 40	8
410 553 40	8
410 654 40	8
410 931 48	9
410 961 48	8
410 962 48	9
410 963 48	9
410 991 40	162
411 102 40	8
411 203 40	8
411 305 40	8
412 102 40	8
412 203 40	8
412 305 40	8
413 025 90	51
413 030 90	51
413 035 90	51
413 038 90	51
413 040 90	51
413 045 90	51
413 055 90	51
413 065 90	51
413 080 90	51
413 905 90	160
413 907 90	160
413 931 94	53
413 961 98	53
413 963 98	54
413 991 90	163
414 001 90	51
414 102 90	51
414 203 90	51
414 304 90	51
415 102 90	51
415 203 90	51
415 304 90	51
416 102 90	52
416 203 90	52
417 102 90	52
417 203 90	52
418 103 90	52
418 153 90	52
418 203 90	52
418 253 90	52
418 303 90	52
419 055 30	52
419 060 30	52
419 070 30	52
419 080 30	52
419 100 30	52
419 106 36	54
419 130 30	52
428 055 30	11

Item No	Page Seite
428 060 30	11
428 070 30	11
428 080 30	11
428 100 30	11
428 106 36	15
428 130 30	11
429 050 40	12
429 060 40	12
429 070 40	12
429 080 40	12
429 100 40	12
429 635 40	12
438 025 40	92
438 026 40	12
438 125 40	12
490 041 10	45
493 063 10	45
494 003 30	45
497 110 40	11
497 635 41	89
498 063 10	45
500 022 10	21
500 032 10	21
500 032 30	24
500 037 30	24
500 043 10	21
500 043 30	24
500 047 10	21
500 047 30	24
500 049 10	21
500 086 10	21
500 088 10	21
500 096 10	21
500 107 10	21
500 111 16	31
500 112 16	31
500 353 10	21
500 353 30	24
500 358 30	24
500 504 10	21
500 505 10	21
500 550 10	22
500 554 10	21
500 556 10	21
500 557 10	21
500 559 10	21
500 610 10	21
500 655 10	21
500 656 10	21
500 657 10	21
500 924 00	30
500 931 14	29
500 933 34	28
500 934 14	29
500 951 16	31
500 951 18	29
500 961 17	27

Item No	Page Seite
500 963 17	27
500 971 18	30
500 971 37	28
500 991 30	166
500 992 10	164
500 994 10	164
500 996 10	165
501 001 10	21
501 010 10	22
501 020 10	22
501 102 10	21
501 102 30	24
501 203 10	21
501 203 30	24
501 207 10	21
501 207 30	24
501 209 10	21
501 305 10	21
502 001 10	21
502 010 10	22
502 020 10	22
502 102 10	21
502 102 30	24
502 107 10	21
502 107 30	24
502 203 10	21
502 203 30	24
502 205 10	21
502 207 10	21
502 207 30	24
502 209 10	21
502 210 10	21
502 305 10	21
507 103 40	22
507 153 40	22
507 203 40	22
507 253 40	22
507 273 40	22
507 303 40	22
507 404 40	22
507 961 48	30
508 051 40	23
508 061 40	23
508 071 40	23
508 083 40	23
508 093 40	23
508 103 30	24
508 103 40	23
508 153 30	24
508 153 40	23
508 203 30	24
508 203 40	23
508 253 30	24
508 253 40	23
508 273 40	23
508 303 40	23
508 404 40	23

Item No	Page <i>Seite</i>
508 454 40	23
508 912 40	165
508 931 34	29
508 961 47	27
508 971 47	28
509 061 40	23
509 071 40	23
509 083 40	23
509 093 40	23
509 103 40	23
509 153 40	23
509 203 40	23
509 253 40	23
509 273 40	23
509 303 40	23
509 404 40	23
511 405 40	21
512 405 40	21
513 025 90	55
513 030 90	55
513 035 90	55
513 040 90	55
513 045 90	55
513 055 90	55
513 065 90	55
513 080 90	55
513 931 14	57
513 951 98	57
513 961 97	56
513 961 98	57
513 991 90	165
514 001 90	55
514 102 90	55
514 203 90	55
514 304 90	55
515 102 90	55
515 203 90	55
515 304 90	55
518 125 90	56
520 045 10	25
520 055 10	25
522 105 10	25
522 205 10	25
527 202 40	26

Item No	Page <i>Seite</i>
527 253 40	26
527 303 40	26
527 403 40	26
527 503 40	26
527 604 40	26
527 805 40	26
528 040 40	26
528 050 40	26
528 055 40	26
528 058 40	26
528 060 40	26
528 068 40	26
528 070 40	26
528 078 40	26
528 080 40	26
528 090 40	26
528 100 40	26
528 110 40	26
528 120 40	26
528 130 40	26
528 140 40	26
538 100 40	25
538 125 40	26
550 045 40	17
550 055 40	17
550 065 40	17
550 080 40	17
550 090 40	17
550 100 40	17
550 120 40	17
550 931 44	19
550 932 44	19
550 951 48	18
550 952 48	18
550 961 47	18
550 993 40	163
551 102 40	17
551 203 40	17
551 305 40	17
552 102 40	17
552 203 40	17
552 305 40	17
580 016 10	159
580 018 10	159

Item No	Page <i>Seite</i>
581 016 10	
581 018 10	159
582 017 10	159
582 225 10	159
583 016 10	159
590 016 10	157
590 018 10	157
590 920 10	178
591 014 10	159
591 016 10	157
591 018 10	157
591 118 10	157
592 016 10	157
592 020 10	157
592 220 10	158
593 016 10	158
600 110 96	60
613 025 90	58
613 030 90	58
613 035 90	58
613 040 90	58
613 055 90	58
613 065 90	58
613 080 90	58
613 090 90	58
613 100 90	58
613 962 98	59
613 973 97	59
613 974 97	59
613 992 90	166
614 001 90	58
614 102 90	58
614 203 90	58
614 304 90	58
615 001 90	58
615 102 90	58
615 203 90	58
615 304 90	58
894 016 20	158
894 020 20	158
895 025 20	158

Verkaufs- und Lieferbedingungen

Nachstehende Lieferbedingungen gelten durch Auftragserteilung als vereinbart. Hier von abweichende Vereinbarungen werden erst durch unsere schriftliche Bestätigung gültig. Sie heben den übrigen Teil der Verkaufs- und Lieferungsbedingungen nicht auf.

1. Angebot und Vertragsabschluss

Unsere Angebote sind freibleibend, Verträge und sonstige Vereinbarungen werden erst durch unsere schriftliche Bestätigung oder durch unsere Lieferung/Leistung verbindlich. Sämtliche Vereinbarungen zwischen uns und unseren Kunden sind bei Vertragsabschluss schriftlich niederzulegen. Bei oder nach Vertragsabschluss getroffene Vereinbarungen zwischen unseren Mitarbeitern oder Vertretern und unseren Kunden bedürfen zu ihrer Gültigkeit unserer schriftlichen Bestätigung; die Vertretungsmacht unserer Mitarbeiter und Vertreter ist insoweit eingeschränkt.

Ergänzungen, Änderungen oder Nebenabreden bedürfen ebenfalls der Schriftform. Dies gilt auch für die Aufhebung des Schriftformerfordernisses.

2. Lieferverpflichtung

Voraussetzung für die Lieferpflicht ist die unbedingte Kreditwürdigkeit des Kunden. Werden die Zahlungsbedingungen nicht eingehalten oder werden Umstände bekannt, die die Kreditwürdigkeit des Kunden ernsthaft in Frage stellen oder wird ein Scheck nicht eingelöst, so werden sämtliche offen stehende Forderungen fällig. Nach fruchtlosem Ablauf einer von uns gesetzten Nachfrist, auch ohne Kündigungsandrohung, sind wir berechtigt, den Vertrag schriftlich zu kündigen und die Lieferungen einzustellen sowie alle bisher erbrachten Lieferungen abzubrechen.

Teillieferungen sind zulässig.

Bei Sonderanfertigungen behalten wir uns eine Mehr- oder Minderlieferung von 10 % vor, auch für den Fall, dass Teillieferungen bereits erfolgt sind oder noch erfolgen. Bestellungen auf Abruf sind, wenn nichts anderes schriftlich vereinbart ist, spätestens innerhalb von einem viertel Jahr nach Ablauf der Vertragsfrist abzunehmen, ohne dass wir die Abnahme unter Fristsetzung annehmen. Nach Ablauf dieser 3 Monate sind wir berechtigt, nach unserer Wahl entweder die Ware in Rechnung zu stellen oder den Auftrag zu streichen. Störungen und Ereignisse höherer Gewalt berechtigen uns, die eingegangene Lieferfrist für die Dauer der Betriebsverhinderung und einer angemessenen Anlaufzeit zu verlängern. Unter Umständen können auch unsere Lieferverpflichtungen ganz oder teilweise aufgehoben werden. Dies gilt auch, wenn uns die Lieferung unmöglich geworden ist, ohne dass wir dieses zu vertreten haben.

Der Kunde kann von uns dann die Erklärung verlangen, ob wir zurücktreten oder innerhalb angemessener Frist liefern. Die Geltendmachung von Ersatzansprüchen in irgendwelcher Art infolge verspäteter Lieferung ist auf einen Maximalwert von 5 % des Auftragswertes beschränkt.

3. Lieferzeit

Die Lieferzeit ist eingehalten, wenn bis zu ihrem Ablauf die Versandbereitschaft mitgeteilt ist, oder der Liefergegenstand das Werk verlassen hat. Der in der Auftragsbestätigung genannte Termin ist freibleibend, wenn nicht eine gesonderte schriftliche Lieferzusicherung erfolgt ist.

4. Preise

Unsere Preise beruhen auf den zum Zeitpunkt der Auftragsannahme gültigen Kalkulationsunterlagen. Lieferungen, die später als 4 Monate nach Vertragsabschluss erbracht werden, berechtigen uns, z.B. bei Lohn- und/oder Materialpreiserhöhungen, eine Anpassung der Preise bis zu maximal 5 % vorzunehmen.

5. Transport

Die Wahl des Transportweges und der Transportmittel erfolgt nach bestem Ermessen ohne Haftung für den billigsten Weg. Sofern uns besondere Vorschriften gegeben werden, erfolgt der Versand entsprechend. Das Transportrisiko trägt in jedem Fall der Empfänger, auch dann, wenn die Lieferung frei Empfangsort oder FOB eines Schiffes vereinbart wird.

Mit Verlassen des Werkes wird die Ware als bedingungsgemäß geliefert betrachtet, auch wenn sie unmittelbar an Dritte gesandt wird.

6. Eigentumsvorbehalt

Die gelieferte Ware bleibt bis zur Erfüllung aller uns aus der gegenseitigen Geschäftsbeziehung zustehenden Ansprüchen unser Eigentum. Der Kunde darf die in unserem Eigentum stehende Ware weder an Dritte verpfänden noch zur Sicherheit übereignen. Bei Pfändung der in unserem Eigentum stehenden Ware ist der Kunde verpflichtet, uns sofort zu benachrichtigen und zwar unter Vorlegung der Pfändungspapiere und einer eidesstattlichen Versicherung, aus der hervorgeht, dass die Ware unser Eigentum ist. Die Kosten für eine evtl. notwendig werdende Intervention trägt der Kunde.

Der Kunde ist berechtigt, die gelieferte Ware im ordnungsgemäßen Geschäftsgang weiter zu veräußern. Im Falle der Weiterveräußerung tritt an die Stelle der gelieferten Ware der Anspruch des Kunden an seinen Abnehmer, der bis zur Höhe unserer gesamten Forderungen schon jetzt als ein uns abgetreten gilt. Der Kunde ist zur Einziehung der Forderung bis auf Widerruf berechtigt. Auf Verlangen ist der Kunde verpflichtet, die Abtretung den Drittschuldnern mitzuteilen und uns die zur Geltendmachung unserer Rechte erforderlichen Auskünfte zu geben und Unterlagen auszuhändigen. Die Abtretung der Forderungen wird von selbst hinfallig, sobald der Kunde die Kaufpreisschuld bzw. alle Verbindlichkeiten aus laufender Geschäftsverbindung beglichen hat. Ist der Eigentumsvorbehalt oder die Abtretung nach dem Recht, in dessen Bereich sich die Ware befindet, nicht wirksam, so gilt die dem Eigentumsvorbehalt und der Abtretung in diesem Bereich entsprechende Sicherung als vereinbart. Ist zur Entstehung solcher Rechte die Mitwirkung des Kunden erforderlich, so ist er auf unsere Anforderung hin verpflichtet, alle Maßnahmen zu treffen, die zur Begründung und Erhaltung solcher Rechte erforderlich sind.

7. Zahlung

Für die Zahlung sind unsere jeweiligen Bedingungen maßgebend. Abzüge jeder Art ohne die entsprechende Vereinbarung sind unzulässig. Eingereichte Schecks gelten erst nach vollständiger Einlösung als Zahlung. Bei Überschreitung der Zahlungsfrist werden vom Fälligkeitstag an unter Vorbehalt der Geltendmachung weiteren Verzugs Schadens Verzugszinsen berechnet. Der berechnete Zinssatz beträgt 9 %. Gerät der Kunde mit seiner Zahlung in Verzug, so steht uns das Recht zu, sofortige Zahlung aller offenen, auch noch nicht fälligen Forderungen oder eine Herausgabe der gelieferten Ware bis zur vollständigen Begleichung unserer Forderung zu verlangen.

8. Gewährleistung

Beanstandungen über Menge und Qualität können nur angenommen und geprüft werden, wenn sie schriftlich innerhalb von 14 Tagen nach Eingang der Ware am Bestimmungsort vorgenommen werden. Waren, die wir als fehlerhaft anerkennen, nehmen wir zurück und liefern dafür Ersatz. Weiter Ansprüche des Kunden können wir nicht anerkennen.

9. Erfüllungsort und Gerichtsstand

Erfüllungsort ist 35279 Neustadt Kreis Marburg, Gerichtsstand - ohne Rücksicht auf die Höhe des Objektes das Landgericht Marburg/Lahn. Maßgebend ist das deutsche Recht.

10. Salvatorische Klausel

Sollten Bestimmungen dieses Vertrages unwirksam, unvollständig oder undurchführbar sein, so bleiben die übrigen Bestimmungen unverändert gültig. In diesem Falle soll eine Regelung gefunden werden, die im Rahmen des gesetzlich Zulässigen wirtschaftlich dem am nächsten kommt, was die Parteien gewollt haben oder gewollt haben würden, wenn sie diesen Punkt bedacht hätten.

Preisliste ist gültig ab 01.03.2012

Terms of Sale and Delivery

The following terms of delivery shall be considered as agreed upon at order placement. Deviating agreements shall only obtain validity by our written confirmation. The deviating agreements shall not rescind the remaining terms of sale and delivery.

1. Quotation and Conclusion of Contract

Our quotations shall be without engagement. Contracts and other agreements shall only become binding through our written confirmation or our performance. All agreements between us and our customers shall be concluded in writing at conclusion of contract. Agreements made between our employees or representatives and our customers during or subsequent to contract conclusion shall only become valid with our written confirmation; the power of attorney held by our employees or representatives shall be limited in this respect. Supplements, modifications or additional agreements also require the written form. This shall also apply to rescinding the requirement of the written form.

2. Delivery Commitment

The customer's unconditional creditworthiness shall be a prerequisite for delivery commitment. Should the terms of payment not be adhered to or circumstances become known which seriously put the customer's creditworthiness into question or if a cheque is not honoured, all receivables become due. On failure of payment within an adequate period of grace set by us, even if devoid of a threat of termination, we shall be entitled to withdraw from the contract in writing and discontinue deliveries and cease all previously performed deliveries. Partial deliveries are admissible. We reserve the right to 10 % over or short delivery for custom-made products, this also applies in case partial deliveries have already been made or are yet to be made. If nothing else has been agreed upon in writing, orders on call must be purchased within three months of expiry of the contractual deadline, without us having to send a reminder containing an explicit purchase deadline. After these three months have expired, we shall optionally be entitled to either invoice the goods or cancel the order. Disruptions and force majeure incidents entitle us to extend the agreed delivery period for the duration of the operative hindrance and a reasonable start-up period. As the case may be our delivery commitments may also be revoked partially or completely. This also applies if it has become impossible for us to deliver at no fault of ours. The customer may then demand our statement as to whether we want to withdraw from delivery or deliver within a reasonable deadline. Compensation claims of any kind resulting from late delivery are limited to 5 % of the order value.

3. Delivery Period

The delivery period shall be deemed as adhered to if readiness for shipment has been notified or the object of delivery has left the manufacturing company before expiry of the delivery period. The deadline mentioned in the order confirmation is without engagement unless a separate written delivery confirmation has been issued.

4. Prices

Our prices are based on the calculation documents applicable at the time of order acceptance. Deliveries which are performed later than four months after conclusion of contract entitle us to adjust the prices by maximally 5%, e.g. in case of wage increases or increases in material prices.

5. Transport

The choice of the route or means of transport is made according to best judgement with no liability for the cheapest route. As far as particular specifications have been provided to us, shipping shall proceed accordingly. The risk of transport shall in any case be borne by the receiver, even if delivery 'free at destination' or FOB a ship has been agreed. On departure from the manufacturing company the goods shall be regarded as delivered according to agreement, even if they are delivered directly to third parties.

6. Reservation of Title

We reserve the title for the delivered goods until all our rightful claims resulting from our mutual business relationship have been fully fled. The customer may neither pledge the goods which are in our property, nor convey them as collateral to third parties. On the seizure of goods which are our property the customer shall be committed to notify us of this immediately and furthermore present us with the seizure documents as well as an affidavit showing that the goods are our property. The expenses for a possibly required intervention shall be borne by the customer. The customer shall be entitled to resell the delivered goods in the regular course of business. In case of a resale, the customer's claim towards the sub purchaser, which is already considered as assigned to us up to the amount of our total receivables, shall replace the delivered goods. The customer is entitled to collect the receivables until such title is revoked. Upon request the customer is committed to notify the garnishees of such assignment and disclose to us any information and hand out any documents to us required in order to protect our rights. The assignment of the receivables shall lapse as soon as the customer has honoured the debt resulting from the purchase price and/or all debt resulting from the current business relationship. Should reservation of title or assignment be invalid according to the jurisdiction in the area where the goods are located, the collateral which applies in that area ensuring reservation of title and assignment shall be considered agreed. Should the customer's cooperation be necessary for the origination of such rights, customer shall be committed to take all measures required in order to constitute and preserve such rights.

7. Payment

Our respective terms are applicable to payment. Deductions of any kind without a respective agreement are prohibited. Cheques that have been handed in shall only be considered as payment after their full encashment. On exceeding the payment deadline default interests shall be charged as of the due date, subject to any claim for further default damages. The charged default interest rate is 9 %. In the event that the customer enters into default with their payment, we have the right to demand immediate payment of all arrears including those which have not yet entered into default, or release of the delivered goods until complete payment of our receivables.

8. Warranty

Complaints concerning quantity and quality can only be accepted and examined if made in writing within 14 days after receipt of the goods at the place of destination. Goods which we acknowledge as being defective will be taken back and replaced. Any additional claims by the customer shall not be recognised by us.

9. Place of Performance and Jurisdiction, Language

Place of performance shall be 35279 Neustadt Kreis Marburg, Federal Republic of Germany. Place of Jurisdiction - notwithstanding the amount of the subject - shall be the Marburg / Lahn district court. German Law shall prevail. Contract language shall be German. In case of dissent the German version shall prevail.

10. Severability Clause

Should any provision of this agreement be or become invalid, ineffective or unenforceable, the validity, effectiveness and enforceability of the remaining provisions shall not be affected thereby. In such event a provision must be found that comes as closest to the legally permitted economic intent and purpose of what the parties had or would have intended had they considered the aspect.

6/09

This price-list is valid with effect from 01.03.2012

